

Springs, Shock Absorbers, Frame, Bumpers (Group 7)

Shock Absorbers

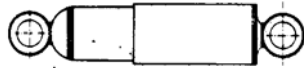

Tube type shocks listed below are original equipment type. We can also supply the same shocks in:

- CS-540.....Coil Booster Shocks\$136.00 pr.
- AS-540.....Air Shocks\$146.00 pr.
- GS-540.....Gas Shocks.....\$185.00 set of 4

1961-1964 All front shock absorbers. Original specs.

- FS-107.....\$63.75 pr.

1961-1964 All rear shock absorbers. Original specs.

- RS-135\$63.75 pr.

1965-1970 All front shock absorbers. Original specs.

- FS-206.....\$63.75 pr.

1965-1970 All rear shock absorbers. Original specs.

- RS-213\$63.75 pr.

1971-1975 All Front. Original Specs.

- FS-202.....\$63.75 pr.

1971-1976 All Rear. Original Specs

- RS-175\$59.00 pr.

-  **1967-1970** All. Front Shock Absorber to upper frame bushings.
SB-376.....\$1.00 ea.

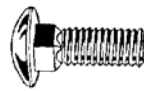

1964-1973 Bumper Bolt. 7/16" x 7/8".

- BB-643\$1.75 kit



1961-1975 License plate rubber bumpers.

- LB-552.....\$2.25 pr.



1967-1975 Gas door. (License plate) Bumper.

- GDB-635\$4.50 pr.



1961-1975 License plate bolt kit.

Two bolts and two nuts per kit.

- LB-300.....\$2.00 kit



1961-1975 License plate nuts. Correct Round head white nylon fits into 5/16" square hole.

- LN-642\$1.25 ea.



1961-1999 License plate nuts. Nylon fits into 3/8" square hole.

- LN-600\$1.25 ea.



1961-1999 License plate screw for above nylon nuts.

- S-8\$0.75 ea.

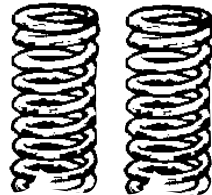

Coil Springs

1961-1975 Front coil springs.

- CS-350F.....\$175.00 per pair

1961-1975 Rear coil springs.

- CS-350R.....\$175.00 per pair

Coil Spring Insulators (7.420)



1961-1966 Pad, front coil spring insulator, upper. Two per car. 5 1/8" O.D.

- SI-381\$13.75 pr.

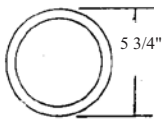

1971-1975 All Front. 5 3/4" O.D.

- SI-715\$13.75 pr.

Made as original with sassel reinforcement. For all 1965 thru 1975 rear Coil Springs. We have noticed that all cars need to have these cushions replaced. Stop that annoying squeak.



- SI-655\$16.00 pr.

Springs, Shock Absorbers and Bumpers (Group 7)

Chassis Paint

All Years: Satin Black paint: This is the Correct Enamel for Frame & Engine Compartment, and is Authentic for All Years;



EP-2.....\$18.00 qt.
EP-2S.....(12 oz. spray can).....\$8.00 ea.

"Miracle Paint" Tough stuff!

Hirsch brand, works very well as tested by our personnel. Bonds to rust, will not crack chip or peel.



Impervious to gasoline, thinner, salt. Can be applied by brush or spray. Quart Cans.

MP300B.....Black.....\$29.00 ea.
MP-300S.....Silver.....\$29.00 ea.
MP-300C.....Clear.....\$29.00 ea.
For 1 gallon cans, add "G"\$87.50 ea.

All Years: Universal Gloss Black: (Excellent for Chassis and General use).

EP-1\$16.00 qt.

Bumper Fillers (7.838)

Rubber Trim Caps between bumper and fender. Beautifully reproduced to detail the finest of show cars.

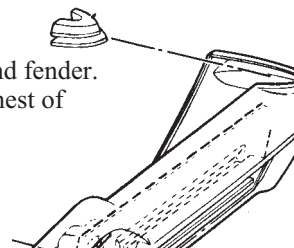

Front

1964 Lesabre, Wildcat, Electra. Fits either side, Front
FF64B\$16.50 ea.

1965 Lesabre, Wildcat, Electra. Front pair
FF65B.....\$16.50 pair

1967 Lesabre, Wildcat, Electra. Front pair
FF67B.....\$23.00 pair

1968 Lesabre, Wildcat, Electra. Front pair
FF68B.....\$23.00 pair

1970 Lesabre, Wildcat, Electra. Front pair
FF70B.....\$18.50 pair

Rear

1967 Lesabre, Wildcat. Rear pair
RF67B\$23.00 pair

1967 Electra. Rear pair
RF67E.....\$23.00 pair

1968 Electra. Rear pair
RF68E.....\$18.25 pair

1969-1970 Electra. Rear pair
RF690E.....\$23.00 pair

Look For Us!

If your thinking of attending any of the shows listed below, be sure to stop by and say "Hello". We will be glad to show you some of our newest items or simply talk about your **BUICK**.

Our spaces will be chock full of NOS and quality reproduction **BUICK** parts. Along with our easy-to-read displays.

Plan ahead by calling-in your order weeks ahead of time. We will be able to bring your entire order and save you shipping too.

<i>Spring Carlisle</i>	<i>IG 73-75</i>
<i>GS Nationals</i>	
<i>Buick National</i>	
<i>Fall Carlisle</i>	<i>IG 73-75</i>
<i>Hershey</i>	<i>WBR-24-7</i>



Bumper Fillers (Group 7)

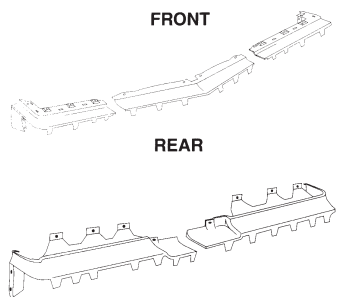

1980-1985 Lesabre
1980-1990 Lesabre Wagon

FF-800S.....Complete Front. 3-piece set.....\$148.00 ea.
 RF-800S.....Complete Rear 2-piece set.....\$190.00 ea.

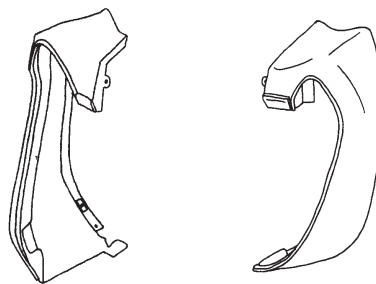

1975-1976 Electra rear 1/4 Panel

Extensions

QE-756S.....Complete Rear 2-piece set.....\$224.00 pr.

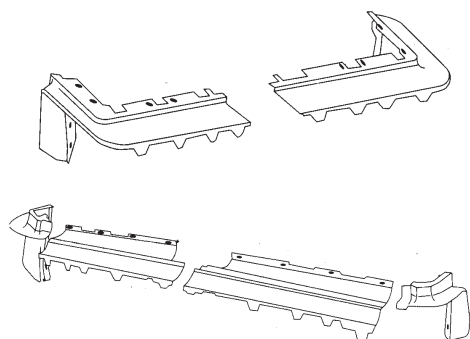

1980-1984 Electra

1982-1986 Electra Wagon

FF-806S.....Complete Front. 2-piece set.....\$148.00 ea.
 RF-806S.....Complete Rear 4-piece set.....\$190.00 ea.
 RF-806OS.....LH & RH Rear Outers.....\$97.00 pr.
 RF-806I.....LH & RH Rear Inner.....\$99.00 pr.

1980-1982 Century 4-door models.

RF-802S.....Complete Rear 4-piece set.....\$176.00 ea.

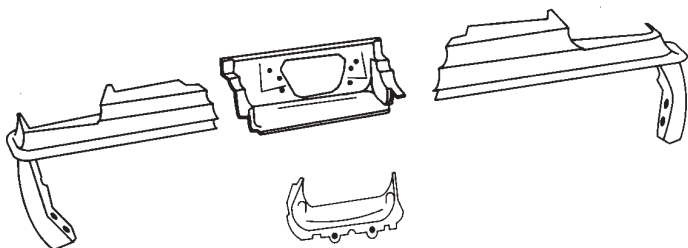

It's easy to 
ORDER BY PHONE!