

Hardware Section - Push-In Wire Clips (Group 17)



1/4" - 3/16" Hole size.
1/2" x 1/2".

MC-3\$0.25 ea.
MC-3B.....Box 100\$8.25 ea.



7/16" Head diameter.
1/4" Hole size.

MC-7\$0.25 ea.
MC-7B.....Box 100\$8.25 ea.

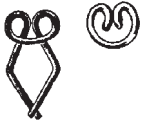

9/16" Head diameter.
5/16" Hole size.

MC-10\$0.25 ea.
MC-10B.....Box 100\$8.75 ea.



5/8" x 5/8" Head.
5/16" Hole size.

MC-13\$0.25 ea.
MC-13B.....Box 50\$8.25 ea.

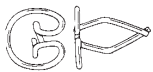

3/4" Head diameter.
5/16" - 3/8" Hole size

MC-16\$0.50 ea.
MC-16B.....Box 100\$38.00 ea.



3/4" x 7/8" Head.
5/16" Hole size.

MC-19TOS
MC-19B.....Box 50TOS



7/8" x 7/8" Head.
5/16" - 3/8" Hole size.

MC-22\$0.25 ea.
MC-22B.....Box 50\$8.25 ea.



1" x 1 1/4" Head.
5/16" - 3/8" Hole size.

MC-25\$0.31 ea.
MC-25B.....Box 100\$18.25 ea.



1/2" Head diameter.
5/16" Hole size.

MC-5\$0.25 ea.
MC-5B.....Box 100\$8.25 ea.



1/2" Head diameter.
5/16" Hole size.
MC-8\$0.25 ea.

MC-8B.....Box 100\$11.00 ea.



17/32" x 3/4" Head.
1/4" or 5/16" Hole size
MC-11\$0.25 ea.

MC-11B.....Box 100\$12.75 ea.



19/32" x 3/4" Head.
5/16" - 3/8" Hole size.

MC-14\$0.50 ea.



3/4" x 15/16" Head.
5/16" Hole size.

MC-17.....\$0.25 ea.
MC-17B.....Box 100\$12.75 ea.



11/16" x 9/16" Head.
5/16" Hole size.

MC-20.....\$0.30 ea.
MC-20B.....Box 100\$16.50 ea.



15/16" x 1 1/16" Head
5/16" - 3/8" Hole size.

MC-23\$0.25 ea.
MC-23B.....Box 50\$8.25 ea.



1 1/16" x 1 1/16"
5/16" - 3/8" Hole size.

MC-26\$1.00 ea.



15/32" Head diameter.
3/16" Hole size.

MCTOS
MC.....Box 100TOS



15/32" x 5/8" Head.
5/16" Hole size.

MC-9\$0.25 ea.
MC-9B.....Box 100\$12.00 ea.



1/2" Head diameter.
1/4" Hole size.
MC-12\$0.25 ea.
MC-12B.....Box 100\$12.00 ea.



21/32" x 3/4" Head.
5/16" Hole size.
MC-15\$0.25 ea.

MC-15B.....Box 100\$12.75 ea.



7/16" x 11/16" Head.
1/4" - 5/16" Hole size.
MC-18\$0.25 ea.

MC-18B.....Box 100\$12.75 ea.



1" x 7/8" Head.
5/16" - 3/8" Hole size.

MC-21\$0.50 ea.



1" x 1 1/8" Head.
5/16" - 3/8" Hole size.

MC-24\$0.50 ea.

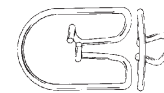

1 1/2" x 2 1/8" Head.
5/16" - 3/8" Hole size.
MC-27\$0.50 ea.

MC-27B.....Box 25\$8.25 ea.



1 3/4" x 1 3/4" Head.
5/16" - 3/8" Hole size.

MC-28\$0.27 ea.
MC-28B.....Box 25\$7.25 ea.





5/8" x 5/8" Head.
1/4" to 5/16" Hole size.
Tabs can be bent or cut to
fit smaller moldings.

MC-54\$0.35 ea.
MC-54B.....Box 25\$7.50 ea.

Hardware Section (Group 17)

Moulding Clips Threaded Type, (Nuts Included)

- 

7/8" | 10 - 24 x 3/4" stud.
MC-63\$0.69 ea.
- 

1 1/8" | 10 - 24 x 3/4" stud.
MC-66\$0.50 ea.
- 

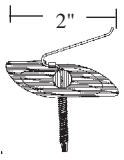
1 3/4" | 12 - 24 x 3/4" stud.
MC-69\$1.00 ea.
- 

2" | 8 - 32 x 1" stud.
MC-72\$0.50 ea.
- 

1 3/4" | 10 - 24 x 1/2" stud.
MC-75\$2.50 ea.
- 

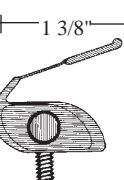
1" | 10 - 24 x 5/8" stud.
MC-64\$0.75 ea.
- 

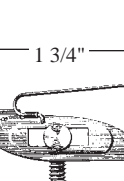
1 3/8" | 10 - 24 x 9/16" stud.
MC-67\$0.50 ea.
- 

1 3/4" | Adjustable.
10 - 24 x 5/8" stud.
MC-70\$1.25 ea.

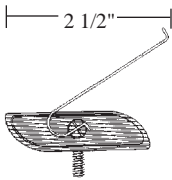
- 

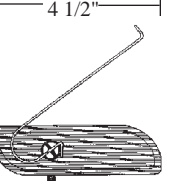
2 1/2" | 12 - 24 x 7/8" stud.
MC-73\$1.00 ea.
- 

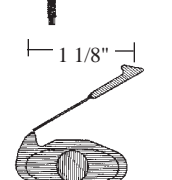
4 1/2" | 10 - 24 x 3/4" stud.
MC-76\$3.25 ea.
- 

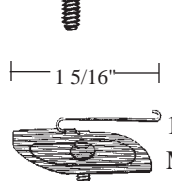
1 1/8" | 10 - 24 x 5/8" stud.
MC-65\$0.50 ea.
- 

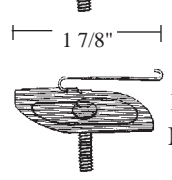
1 5/16" | 10 - 24 x 3/4" stud.
MC-68\$0.75 ea.
- 

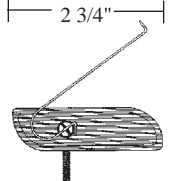
1 7/8" | 10 - 24 x 5/8" stud.
MC-71\$0.79 ea.
- 

2 3/4" | 8 - 32 x 3/4" stud.
MC-74\$0.75 ea.

Universal Break-Off Type

- 

10 - 24 x 3/4" stud.
MC-1\$1.00 ea.

Door Panel Fasteners

- 

Head Dia.3/4"
Stem Length.1/2"
Fits Hole Size.1/4"
DPF-1\$0.50 ea.
- 

Head Dia.7/8"
Stem Length.3/4"
Fits Hole Size.1/4"
DPF-2\$0.50 ea.
- 

Head Dia.3/4"
Stem Length.3/4"
Fits Hole Size.1/4"
DPF-3\$0.50 ea.
- 

Head Dia.15/16"
Stem Length.1 1/4"
Fits Hole Size.1/4"
DPF-4\$0.55 ea.
- 

Head Dia.15/16"
Stem Length.5/16"
Fits Hole Size.11/16"
DPF-5\$0.50 ea.
- 

Head Width.7/16"
DPF-6\$1.00 ea.

- 

Head Width.5/8"
DPF-7\$0.85 ea.
- 

Head Dia.1/2"
Stem Length.3/4"
Fits Hole Size.1/4"
DPF-8\$0.30 ea.

Misc. Retainers

- 

Head Dia.7/16"
Stem Length.7/16"
Fits Hole Size.1/8"
WF-2\$0.75 ea.
- 

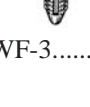
Head Dia.7/16"
Stem Length.5/8"
Fits Hole Size.1/8"
WF-3\$1.00 ea.
- 

Head Dia.9/16"
Stem Length.3/4"
Fits Hole Size.1/8"
WF-4\$0.75 ea.

Hardware Section - (Group 17)

Push-In Clips

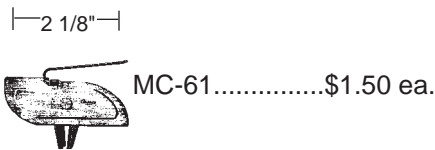
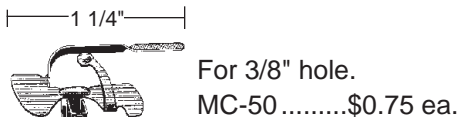
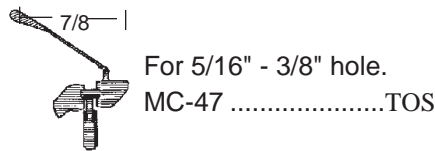
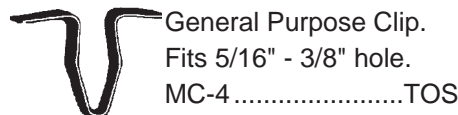
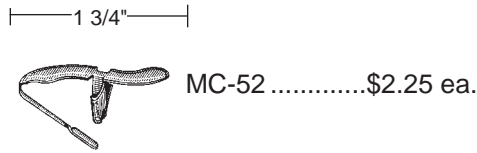
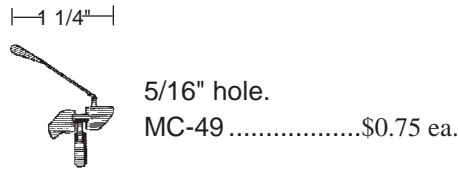
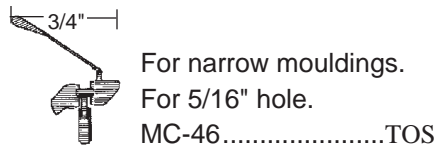
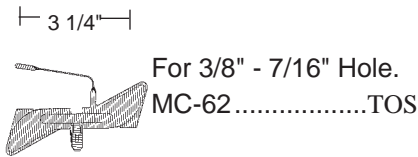
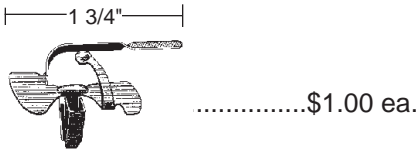
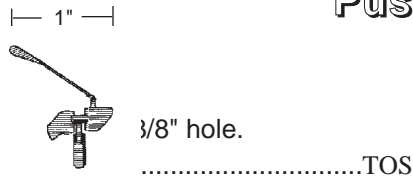

Door Moulding End Clips

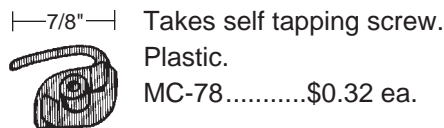
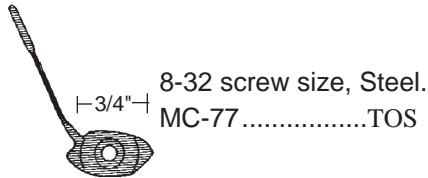

Nylon Clips

Push into oval holes in panels, then moulding snap over them.

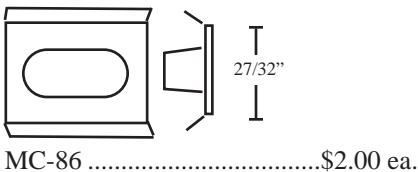
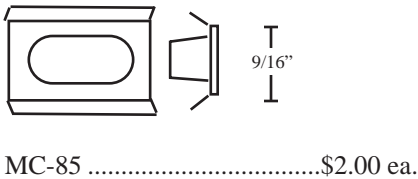
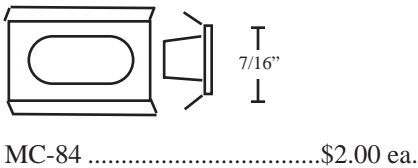

Chrome Trim Screws



#6 Chrome Plated Phillips Oval Head

TS-612.....6x1/2".....	\$0.35
TS-658.....6x5/8".....	\$0.35
TS-634.....6x3/4".....	\$0.35
TS-678.....6x7/8".....	\$0.35
TS-6100.....6x1".....	\$0.40
TS-6114.....6x1 1/4".....	\$0.40

#8 Chrome Plated Phillips Oval Head

TS-8386...8x3/8" w/ #6 Head	\$0.35
TS-812.....8x1/2".....	\$0.35
TS-8126...8x1/2" w/ #6 Head	\$0.40
TS-858.....8x5/8".....	\$0.35
TS-8586...8x5/8" w/ #6 Head	\$0.35
TS-834.....8x3/4".....	\$0.40
TS-8346...8x3/4" w/ #6 Head	\$0.40
TS-83410..8x3/4" w/ #10 Head	\$0.40
TS-878.....8x7/8".....	\$0.40
TS-8786...8x7/8" w/ #6 Head	\$0.40
TS-8100.....8x1".....	\$0.40
TS-81006...8x1" w/ #6 Head	\$0.45
TS-8118.....8x1 1/8".....	\$0.45
TS-81186..8x1 1/8" w/ #6 Head	\$0.45
TS-8114.....8x1 1/4".....	\$0.45
TS-81146..8x1 1/4" w/ #6 Head	\$0.45
TS-8112.....8x1 1/2".....	\$0.45
TS-81126..8x1 1/2" w/ #6 Head	\$0.50
TS-81346..8x1 3/4" w/ #6 Head	\$0.60

#10 Chrome Plated Phillips Oval Head

TS-1012.....10x1/2".....	\$0.45
TS-10128...10x1/2" w/ #8 Head	\$0.45
TS-1058.....10x5/8".....	\$0.45
TS-1034.....10x3/4".....	\$0.45
TS-1000.....10x1".....	\$0.45
TS-10008...10x1" w/ #8 Head	\$0.50
TS-10114.....10x1 1/4".....	\$0.50
TS-101126..10x1 1/2" w/ #6 Head	\$0.50
TS-10134..10x1 3/4" w/ #6 Head	\$0.60

Hardware Section (Group 17)

Universal Wire Moulding Clips -Push-in Type



5/16" - 1/2" Moulding.
3/8" Hole size.

MC-29\$0.34 ea.
MC-29B.....Box 50\$12.00 ea.



5/8" - 1" Moulding.
7/16" Hole size.

MC-30\$0.50 ea.
MC-30B.....Box 50\$14.25 ea.



1 1/8" - 3" Moulding.
1/2" Hole size.

MC-31\$1.00 ea.
MC-31B.....Box 25\$19.25 ea.

Windshield and Backglass Moulding Clips



1969-1975
1969-
1970:

Lesabre & Wildcat two door models. Backglass. 22 per car;
1971-1972: All Electra, Lesabre and Wildcat four door hardtops. Backglass. As required;
1971-1972: All Electra. Backglass. As required;
1973-1975: All windshield. Backglass & 1/4" glass. As required.
MC-32\$0.75 ea.



1968-1971

1968: All with soft roof trim. Windshield

upper & side. Backglass. As required;
1969-1971: All windshield & backglass. As required.
MC-33\$0.75 ea.
1968-1973 All windshield & Backglass
(Emergency) As required.
MC-35\$1.00 ea.



1965-1968

All windshield & Backglass. As required.
MC-34\$1.00 ea.
1966-1975 All as required.
Windshield & Backglass.
(Emergency - screw-on type).
MC-37\$1.75 ea.

Other Windshield - Backglass Clips (Use as required)

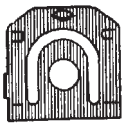

Windshield & backglass clips. Use as required.
MC-40 ..\$0.75 ea.

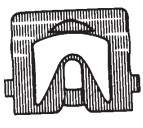

Windshield & backglass clips. Use as required.
MC-41 ...\$0.75 ea.



Windshield & backglass clips. Use as required.
MC-42\$0.75 ea.

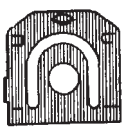

Windshield & backglass clips. Use as required.
MC-43 ..\$0.75 ea.

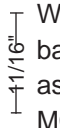
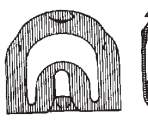

Windshield & backglass clips. Use as required.
MC-44.....\$0.75 ea.

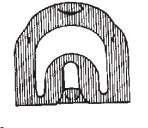

Windshield & backglass clips. Use as required.
MC-39.....\$1.00 ea.

Window Rollers (see also window bearings on next page)



1957 thru 1972 all as required
WR-576\$2.75

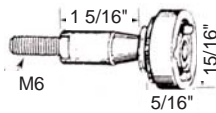

1978 thru 1995 all as required. 5/16 wide
WR-785\$4.50

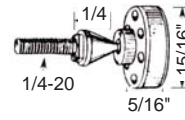

1963-1967 Riviera and as required. 7/8" wide.
WR-637\$3.50



1968 thru 1978 all as required. 7/16 wide
WR-682\$9.50 ea.

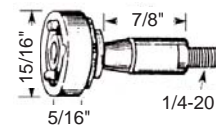

1968-1975 as required. 5/16 w.
WR-685\$3.50

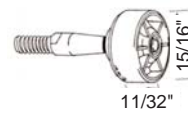

1969-1974 as required. 11/32" wide
WR-694.....\$5.00

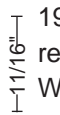

1972 thru 1999 all as required. .11/64" id
WR-727\$2.00 ea.

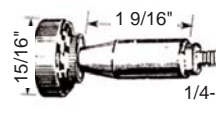

1971-1980 as required. 5/16" w
WR-710.....\$4.50



1979-2004 as req. With metal insert.
WR-790\$3.50

11/16 wide

Hardware Section (Group 17)



Tubular Nuts (8.921)



For attaching monograms, emblems, etc. with studs. Measure your pin diameter and the size of the hole. Consider nylon tubular nuts. Although not original, they will not rust or chip paint.

Stud size 1/16" Hole size 9/64"
 TN-1.....Nylon\$0.40 ea.
 TN-1P.....Pack of 25\$7.50

Stud size 3/32" Hole size 1/8"
 TN-2.....Steel\$0.35 ea.
 TN-2P.....Pack of 25\$6.50

Stud size 1/8" Hole size 5/32"
 TN-3.....Steel\$0.35 ea.
 TN-3P.....Pack of 25\$6.50

Stud size 5/64" Hole size 5/32"
 TN-4.....Nylon\$0.40 ea.
 TN-4P.....Pack of 25\$7.50

Stud size 1/8" Hole size 11/64"
 TN-5.....Nylon\$0.45 ea.
 TN-5P.....Pack of 25\$8.50

Stud size 1/8" Hole size 3/16"
 TN-6.....Steel\$0.40 ea.
 TN-6P.....Pack of 25\$7.50

Stud size 1/8" Hole size 1/4"
 TN-7.....Steel\$0.45 ea.
 TN-7P.....Pack of 25\$8.50

Stud size 5/32" Hole size 7/32"
 TN-8.....Steel\$0.45 ea.
 TN-8P.....Pack of 25\$8.50

Stud size 5/32" Hole size 3/16"
 TN-9.....Nylon\$0.40 ea.
 TN-9P.....Pack of 25\$7.50

Stud size 3/16" Hole size 7/32"
 TN-10.....Steel\$0.45 ea.
 TN-10P.....Pack of 25\$8.50

Stud size 3/16" Hole size 13/64"
 TN-11.....Steel\$0.45 ea.
 TN-11P.....Pack of 25\$8.50

Stud size 1/4" Hole size 5/16"
 TN-12.....Steel\$0.50 ea.
 TN-12P.....Pack of 25\$9.50



Flat Nuts (8.921)

For attaching monograms, emblems, etc. with studs.
 Measure your stud diameter.

FN-1.....1/16"\$0.25 ea.
 FN-1P.....Pack of 25\$4.50

FN-2.....3/32"\$0.25 ea.
 FN-2P.....Pack of 25\$4.50

FN-3.....1/8"\$0.25 ea.
 FN-3P.....Pack of 25\$4.50

FN-4.....5/32"\$0.25 ea.
 FN-4P.....Pack of 25\$4.50

FN-5.....3/16"\$0.25 ea.
 FN-5P.....Pack of 25\$4.50

FN-6.....1/4"\$0.30 ea.
 FN-6P.....Pack of 25\$5.50

FN-7.....5/16"\$0.30 ea.
 FN-7P.....Pack of 25\$5.50



Round Flat Nuts (8.921)

FN-8.....1/8"\$0.30 ea.
 FN-8P.....Pack of 25\$5.50

FN-9.....3/16"\$0.30 ea.
 FN-9P.....Pack of 25\$5.50

Cage Nuts / "U" Nuts (8.155)



1935-1960 All as required. Cage Nut.

CN-363\$1.50 ea.

For 5/16"-18 Screw.
 Range - .025" - .060"

Center of hole to edge - 9/16"
 UN-1\$0.50 ea.
 UN-1B....Box of 50\$16.50 ea.

For 3/8"-16 Screw.
 Range - .050" - .200"

Center of hole to edge - 3/4"
 UN-2\$0.65 ea.
 UN-2B....Box of 25\$14.50 ea.

Thread Cutting Nuts



Sold in packs of 25 pieces (8.921)

5/16" Hex. For 1/4" stud.
 7/16" washer OD. Zinc Plated
 TCN-516\$4.00 pack

3/8" Hex. For 3/16" stud.
 1/2" washer OD. Zinc Plated
 TCN-38\$4.00 pack

11/32" Hex. For 5/32" stud.
 9/16" washer OD. Zinc Plated
 TCN-1132\$4.00 pack

7/16" Hex. For 1/4" stud.
 11/16" washer OD. Zinc Plated
 TCN-716\$4.25 pack

Window Bearings



1968-1974 as required.
 low profile. 1 7/32" dia.
 WB-684A\$3.50



1968-1974 as required.
 1" dia.
 WB-684B.....\$3.50



1968-1974 as required.
 1" dia. high cap
 WB-684C\$3.50

Hardware Section (Group 17)