

# Electrical ( Group 2 )

## Starter Rebuilding Service

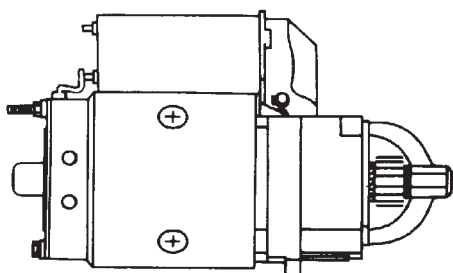

(Includes Solenoid)  
(See Group 2.041 in NOS section  
for outright sales).

<b>1961-1963</b> All 215 V-8. S-613 .....	\$ 95.00 ea.
<b>1962-1963</b> All V-6. Exchange. S-623S .....	\$ 95.00 ea.
<b>1964-1967</b> 225, 300, 340 engines. S-647 .....	\$ 95.00 ea.
<b>1965-1966</b> GS 400 engines. (\$25.00 Core Charge) S-646 .....	\$ 132.50 ea.
<b>1967-1972</b> 400 and 455 engines. S-674 .....	\$ 95.00 ea.
<b>1968-1972</b> 350 engines. S-684 .....	\$ 95.00 ea.

## Starter ID Tag

**1961-1967** Delco,  
starter, generator  
and distributor ID  
tag. (Red).



ET-12 .....	\$ 6.00 ea.
-------------	-------------

## Ignition Coils

<b>1961-1972</b> IC-539 .....	\$ 23.00 ea.
<b>1961-1972</b> IC-539D....(Genuine Delco) .....	\$ 32.50 ea.
<b>1961-1972</b> Resistor. ICR-534 .....	\$ 10.50 ea.



### Universal Coil Bracket.

CB-350 .....	\$7.50 ea.
CB-350C.....(Chrome) .....	\$9.50 ea.

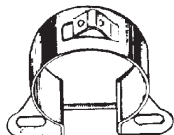

## Starter Solenoids

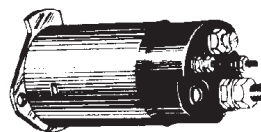

<b>1961-1972</b> All. SS-575 .....	\$ 33.50 ea.
---------------------------------------	--------------

## Starter Solenoid Repair Kit



<b>1961-1972</b> All. SRK-570 .....	\$ 20.25 ea.
--	--------------

## Starter Brush Sets

<b>1961-1972</b> Brush Set. SBS-539 .....	\$ 5.50 set
--	-------------

## Starter Drives

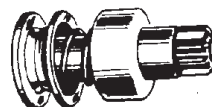

<b>1961-1972</b> All. SD-615 .....	\$ 23.75 ea.
---------------------------------------	--------------

## Starter Repair Kit

<b>1964-197</b> All V-8. Includes Starter Drive, Brushes, Front & Rear Bushings, Washers & Snap Rings. SRK-648 .....	\$27.00 ea.
--	-------------

## Wire & Cable Retainers

<b>1964-1972</b> Engine compartment wiring strap. 7" long. WS-5 .....	\$1.50 ea.
---	------------



<b>1964-1972</b> Engine compartment wiring strap. WS-6 2 3/4" Black .....	\$0.75 ea.
WS-7 4" Black .....	\$0.75 ea.
WS-8 4 1/2" Black .....	\$0.75 ea.
WS-9 8 3/4" Black .....	\$0.75 ea.



<b>1961-1966</b> Side Frame Rail Wire Retainers. WR-616 .....	\$4.75 ea.
--	------------



<b>1967-1972</b> All. Retains positive battery cable to side frame rail. WR-672 .....	\$3.00 ea.
---	------------

# Electrical ( Group 2 )

If you are looking for the **Best Reproduction** of the original **Delco** Batteries, this is it! They are manufactured from original tooling using today's advanced technology. All batteries have the correct "**Delco**" and "**Energizer**" trademarks embossed into the rubber casing. All dimensions are correct as original. The "**Tar Top**" versions feature correct caps. The "**Hardtop**" versions come complete with "**Delco Eye**". Batteries are shipped dry charged and can be stored virtually forever. Battery acid can be obtained locally. Batteries are sold as pictured, however, we can reverse posts from front to rear if desired. (Sorry, no COD's on batteries).

Delco Replacement Batteries are also available for most Buicks;  
Please ask for your model / year.



"Tar Top"  
"DC-12"



"Hard Top"  
"Energizer"  
(with Delco eye)

1965 GS with bottom  
lefthand takes BC-645  
with end pointed directly  
opposite

## 1963-1966

1963 All V-8;  
1964-1966 All.

B-12.....

## 1967-1971

1967 All;  
1968-1971 350 engines.

B-59.....

## Battery Hold Down Clamps Battery Hold Down Bolts

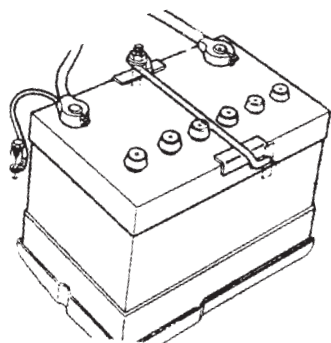

As original, 1961 thru 1967 clamps are  
Rubber Coated Steel.

1961-1963 All. (Clamp only)

BC-613 .....\$TOS ea.

1964-1965 All. Except GS.

BC-645.....\$ 24.50 ea.

1965 GS.

BC-65GS.....\$24.50 ea.

1966-1967 All.

BC-657.....\$ 24.50 ea.



1961-1962 All inside. Cut to  
length if necessary. Includes washer and  
nut.

BB-612 .....\$5.50 ea.

1961-1967

1961-1962 All outside;

1963-1967 All. Includes washer  
and nut

BB-610 .....\$4.50 ea.

## Battery Trays

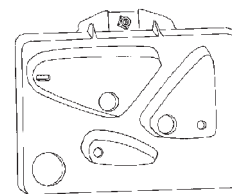

1968-1972 All. Includes clamp  
and bolt.

BT-682.....\$35.25 ea.



**Clamp only.**

BC-682.....\$4.25 ea.

**Bolt only.**

BB-682.....\$2.00 ea.

# Electrical ( Group 2 )

## Battery Cables

Our **battery cables** listed below for **TOP POST** batteries are made with heavy duty two (2) gauge copper wire, covered with black insulation.



Our reproduction "**Spring Ring**" cables are made from GM blueprints to be identical to the originals in fit and functions. They are sold in pairs. "Spring Ring" cables are also sold individually.

*Inquire!*

### Years

### Replacement Cables

(+) Positive Price (-) Negative Price

1961-1962 All.....	BC-24.....	\$13.25 ea.	BC-17.....	\$11.50 ea.
1963 All V-6.....	BC-24.....	\$13.25 ea.	BC-19.....	\$11.75 ea.
1963 All V-8.....	BC-31.....	\$17.50 ea.	BC-17.....	\$11.50 ea.
1964-65 300 engines.....	BC-38.....	\$18.75 ea.	BC-31.....	\$17.50 ea.
1965-66 400 eng. GS.....	BC-31.....	\$17.50 ea.	BC-24.....	\$13.25 ea.
1966-67 300, 340.....	BC-38.....	\$18.75 ea.	BC-31.....	\$17.50 ea.
1967-68 350, 400.....	BC-48.....	\$23.00 ea.	BC-31.....	\$17.50 ea.
1969 350.....	BC-42.....	\$21.00 ea.	BC-24.....	\$13.25 ea.
1969 400.....	BC-48.....	\$23.00 ea.	BC-31.....	\$17.50 ea.
1970-72 350.....	BC-42.....	\$21.00 ea.	BC-31.....	\$17.50 ea.
1970-72 455.....	BC-48.....	\$23.00 ea.	BC-31.....	\$17.50 ea.

### Geniune "Spring Ring" Sets



BC-248.....	\$73.00 pr.
BC-258.....	\$73.00 pr.
BC-255.....	\$73.00 pr.
BC-264.....	\$73.00 pr.
BC-285.....	\$73.00 pr.
BC-287.....	\$73.00 pr.
BC-294.....	\$73.00 pr.
BC-300.....	\$73.00 pr.

## Side Terminal Cables - Delco Replacements

1972 350 engines.....	BC-35S.....	\$19.25 ea.	BC-30S.....	\$19.25 ea.
1972 455 engines.....	BC-45S.....	\$19.75 ea.	BC-30S.....	\$19.75 ea.

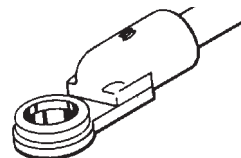

## Fabric Wire Loom



Some battery cables came from the factory covered with this material. It is recommended by Delco for extra protection.

WL-180.....	1/8" ID.....	\$1.00 ft.
WL-316.....	3/16" ID.....	\$1.00 ft.
WL-140.....	1/4" ID.....	\$1.25 ft.
WL-516.....	5/16" ID.....	\$1.25 ft.
WL-380.....	3/8" ID.....	\$1.25 ft.
WL-716.....	7/16" ID.....	\$1.25 ft.
WL-120.....	1/2" ID.....	\$1.25 ft.
WL-916.....	9/16" ID.....	\$1.50 ft.
WL-580.....	5/8" ID.....	\$1.75 ft.
WL-340.....	3/4" ID.....	\$1.75 ft.

 **1961-1972 Battery Cable Cover.**  
CC-315.....\$5.50 ea.

**1961-1972 All. Battery Cable Cover. Located on switch side & junction block.**

 (Two per car).  
CC-325.....\$5.50 ea.

## Battery Terminal Protectors

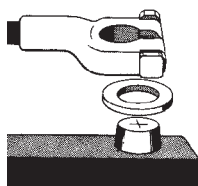

Stops corrosion indefinitely. Two protectors in each kit.  
BW-300.....\$3.25 kit

## Nylon Wire Loom

NWL-140.....	1/4" ID.....	\$1.50 ft.
NWL-380.....	3/8" ID.....	\$1.50 ft.
NWL-120.....	1/2" ID.....	\$1.50 ft.
NWL-340.....	3/4" ID.....	\$1.75 ft.

## Wiring Harness Tape

Non-adhesive vinyl Harness wrap is same as used by GM. 1" wide, 100 foot roll.  
WT-100.....1" wide.....\$11.00 roll

# Electrical ( Group 2 )

## Ignition Switches

(See NOS section-Group 2.188 for models not listed)

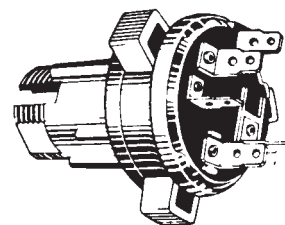

Years	Cars #	Price
1964 All	IS-64S	\$30.25 ea.
1965 All	IS-65S	\$24.75 ea.
1966-1967 All	IS-667	\$49.50 ea.
1968 All	IS-68	SEE NOS
1969-1972 (All tilt wheel)	IS-699T	\$23.00 ea.
1969-1972 (All without tilt)	IS-699	\$29.50 ea.

## Ignition Lock Cylinder with Keys

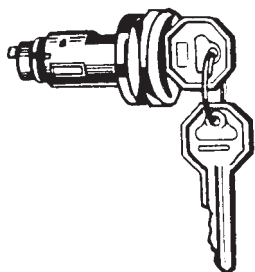

Years	Cars #	Price
1961,1962 All	IL-614	\$38.50 kit.
1963 All	IL-63S	\$28.00 kit.
1964 All	IL-614	\$38.50 kit.
1965 All	IL-65	\$14.75 kit.
1966-1967 All	IL-667	\$13.25 kit.
1968 All	IL-68	\$13.25 kit.
1969 and 1972 All	IL-695	\$14.75 kit.



## Key Blanks (Genuine GM)

We can also make keys from your code. Please inquire.

1961-1966 Door and Ignition - Octagon.	
KB-10	\$3.25 ea.
1961-1966 Glove and Trunk - Rounded.	
KB-11	\$3.25 ea.
1967 & 1971 Door and Ignition - Rectangular.	
KB-48	\$3.25 ea.
1967 & 1971 Glove and Trunk - Oval.	
KB-49	\$3.25 ea.
1968 & 1972 Door and Ignition - Rectangular.	
KB-50	\$3.25 ea.
1968 & 1972 Glove and Trunk - Oval.	
KB-51	\$3.25 ea.
1969 & 1973 Door and Ignition - Rectangular.	
KB-44	\$3.25 ea.
1969 & 1973 Glove and Trunk - Oval.	
KB-45	\$3.25 ea.
1970 Door and Ignition - Rectangular.	
KB-46	\$3.25 ea.
1970 Glove and Trunk - Oval.	
KB-47	\$3.25 ea.

1974 Ignition - Rectangular.	
KB-46	\$3.25 ea.
1974 Glove, Door and Trunk - Oval.	
KB-47	\$3.25 ea.
1975-1979 & 1983-1985 Ignition - Rectangular.	
KB-48	\$3.25 ea.
1975-1979 & 1983-1985 Glove, Door and Trunk - Oval.	
KB-49	\$3.25 ea.
1976 & 1980 Ignition - Rectangular.	
KB-50	\$3.25 ea.
1976 & 1980 Glove, Door and Trunk - Oval.	
KB-51	\$3.25 ea.



## Key Caps



1967 thru 1985 All Rectangular Keys	
KC-670R	\$1.00 ea.
1967 thru 1985 All Oval Keys	
KC-670O	\$1.00 ea.

# Electrical ( Group 2 )

## Tune-ups Kits

Tune-up Parts

Quality Replacement parts

for all **1961-1972** Models.



*Complete Tune-up kit includes: Points, Plugs, Wires, Cap, Rotor & Condenser.*



### 1961-1963 \* V-8

CARS#:	YEARS:	APPLICATION:	PRICE:
D-106	1961-1963	Point Set .....	\$9.50 ea.
D-203	1961-1963	Condenser.....	\$4.00 ea.
D-308	1961-1963	Distributor Cap.....	\$11.00 ea.
D-409	1961-1963	Rotor.....	\$5.75 ea.

#### Complete Tune-up Kit

TK-613.....\$64.25 ea.

### 1966-1967 \* V-6

CARS#:	YEARS:	APPLICATION:	PRICE:
D-106	1966-1967	Point Set .....	\$9.50 ea.
D-204	1966-1967	Condenser.....	\$4.00 ea.
DC-67	1966-1967	Distributor Cap.....	\$10.50 ea.
D-413	1966-1967	Rotor.....	\$6.25 ea.

\*1966 cars with adjusting window in front of distributor

#### Complete Tune-up Kit

TK-67.....\$66.50 ea.

### 1962-1966 \* V-6

CARS#:	YEARS:	APPLICATION:	PRICE:
D-106	1962-1966	Point Set .....	\$9.50 ea.
D-203	1962-1966	Condenser.....	\$4.00 ea.
DC-626	1962-1966	Distributor Cap.....	\$9.50 ea.
D-413	1962-1966	Rotor.....	\$6.25 ea.

\* 1966 cars with adjusting window on side of distributor

#### Complete Tune-up Kit

TK-626.....\$64.25 ea.

### 1964-1972 V-8

CARS#:	YEARS:	APPLICATION:	PRICE:
D-106	1964-1972	Point Set .....	\$9.50 ea.
D-203	1964-1965 1965	Condenser..... With side adjusting window condenser	\$4.00 ea. \$4.00 ea.
D-204	1966 1967-1972	With window front: All. Condenser.....	\$4.00 ea. \$4.00 ea.
D-308	1964-1972	Distributor Cap.....	\$11.00 ea.
D-409	1964-1972	Rotor.....	\$5.75 ea.

#### Complete Tune-up Kit

TK-642.....\$64.25 ea.

# Electrical ( Group 2 )



## Spark Plugs

1961-1963 215 V-8 with 2BBL Carb.

SP45FFS.....\$2.50 ea.

### 1961-1964

1961-1963: 215 V-8 with 4BBL carb.;

1964: All 300.

SP44FFS.....\$2.25 ea.

### 1962-1967 All V-6.

SP-44S.....\$2.75 ea.

### 1965-1967 300 and 340 engines with 2BBL carb.

SP-45S.....\$2.50 ea.

### 1965-1967

1965-1966: 300, 340 and 400 with 4BBL carb.;

1967: 340 engines with 4BBL carb.

SP-44S.....\$2.75 ea.

### 1967-1971

1967-1969: 400 engines;

1970-1971: 350 4BBL GS;

1970-1971: All 455 engines.

SP-44TS .....\$2.50 ea.

### 1968-1972

1968-1971: All 350 engines exc. GS;

1972: All.

SP-45TS .....\$2.50 ea.



## Spark Plug Wire Sets

CARS#:	YEARS:	APPLICATION:	PRICE:
IW-576	1961-1966	All V-8.....	\$23.00 ea.
IW-629D	1962-1967	All 6 Cyl ...(Delco).....	\$35.75 ea.
IW-674	1967-1972	All V-8.....	\$23.00 set
IW-576D	1961-1966	All V-8.....(Delco) .....	\$44.50 ea.
IW-672D	1967-1972	All V-8.....(Delco) .....	\$35.75 ea.



1961-1966: All;

1966: 300, 340, 400 engine ign. wire retainer on rocker covers. Two per car.

WR-596.....\$3.50 ea.



1967-1972 All. Front "4", ign. wire retainer. Two per car

WR-683.....\$3.50 ea.



1967-1972 All. Rear "3" ign. wire retainer

WR-673.....\$3.50 ea.

## Spark Plug Rubber Boots



Correct for all 1961-1967 Models.

SB-577.....\$2.25 ea.

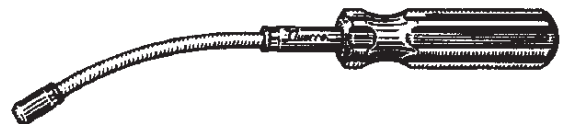

## Distributor Adjusting Tool

1961-1972 All. If you have ever tried to adjust your points without this tool you know how **NECESSARY** it is.

DT-575 .....\$ 8.25 ea.

# Electrical ( Group 2 )

## DATE CODED SPARK PLUG WIRE SETS

For those requiring the best for their show ready car, these reproduction wire sets are unsurpassed. They are manufactured to original GM blueprint specifications. They include the proper boots, terminals, script and correct factory length. All wires are carbon core for radio suppression. They come correctly identified with "**Packard Radio TVRS**" or "**Radio GM**" along with the proper date code to match your car.

Date codes will read as such: 3 Q 67. The first number, "3" corresponds to the third quarter of the year. "Q" means quarter. The last number, "67", is the year, 1967. Thus, a cable marked 3 Q 67 was produced in the third quarter of 1967. You should order your spark plug wire sets with dates that are 6 to 12 months prior to the manufacturing date of your car. *Note:* wires were not dated on vehicles prior to January 1961.



1964-1966 Special, Skylark and GS.  
300, 340 and 400 C.I. V-8 All.



1967-1971 300, 340 and 350 C.I. V-8 All.



1972 350 and 455 C.I. V-8 All.

Year	Application	Date	Part Number	Price
1961	V-8 All 2 Barrel		W3324.....\$68.00 ea.	
1961	V-8 All 2 Barrel	1-Q-61	W3324611.....\$68.00 ea.	
1961	V-8 All 4 Barrel		W3336.....\$68.00 ea.	
1961	V-8 All 4 Barrel	1-Q-61	W3326611.....\$68.00 ea.	
1962	V-8 All 2 Barrel	3-Q-61	W3324613.....\$68.00 ea	
1962	V-8 All 2 Barrel	1-Q-62	W3324621.....\$68.00 ea	
1962	V-8 All 4 Barrel	3-Q-61	W3326613.....\$68.00 ea	
1962	V-8 All 4 Barrel	1-Q-62	W3326621.....\$68.00 ea	
1963	V-8 All 2 Barrel	3-Q-62	W3324623.....\$68.00 ea	
1963	V-8 All 2 Barrel	1-Q-63	W3324631.....\$68.00 ea	
1963	V-8 All 4 Barrel	3-Q-62	W3326623.....\$68.00 ea	
1963	V-8 All 4 Barrel	1-Q-63	W3326631.....\$68.00 ea	
1964	V-8 All 300, 340 & 400 C.I.	3-Q-63	W3334633.....\$68.00 ea	
1964	V-8 All 300, 340 & 400C.I.	3-Q-64	W3336641.....\$68.00 ea	
1965	V-8 All 300 & 340 C.I.	3-Q-64	W3334643.....\$68.00 ea	
1965	V-8 All 300 & 340 C.I.	1-Q-65	W3334651.....\$68.00 ea	
1966	V-8 All 300 & 340 C.I.	3-Q-65	W3334653.....\$68.00 ea	
1966	V-8 All 300 & 340 C.I.	1-Q-66	W3334661.....\$68.00 ea	
1966	V-8 All 300, 340 & 400 C.I.	3-Q-65	W3330653.....\$68.00 ea	
1966	V-8 All 300, 340 & 400 C.I.	1-Q-66	W3330661.....\$68.00 ea	
1967	V-8 All 300, 340 C.I.	3-Q-66	W3338663.....\$68.00 ea	
1967	V-8 All 300, 340 C.I.	1-Q-67	W3338671.....\$68.00 ea	
1967	V-8 All 400, 430 & 455 C.I.	3-Q-66	W3342663.....\$68.00 ea	
1967	V-8 All 400, 430 & 455 C.I.	1-Q-67	W3342671.....\$68.00 ea	

# Electrical ( Group 2 )

Year	Application	Date	Part Number	Price
1968	V-8 All 350 C.I.	3-Q-67	W3338673.....	\$68.00 ea
1968	V-8 All 350 C.I.	1-Q-68	W3338681.....	\$68.00 ea
1968	V-8 All 400 C.I.	3-Q-67	W3342673.....	\$68.00 ea
1968	V-8 All 400 C.I.	1-Q-68	W3342681.....	\$68.00 ea
1969	V-8 All 350 C.I.	3-Q-68	W3338683.....	\$68.00 ea
1969	V-8 All 350 C.I.	1-Q-69	W3338691.....	\$68.00 ea
1969	V-8 All 400 C.I.	3-Q-68	W3342683.....	\$68.00 ea
1969	V-8 All 400 C.I.	1-Q-69	W3342691.....	\$68.00 ea
1970	V-8 All 350 C.I.	3-Q-69	W3338693.....	\$68.00 ea
1970	V-8 All 350 C.I.	1-Q-70	W3338701.....	\$68.00 ea
1970	V-8 All 455 C.I.	3-Q-69	W3342693.....	\$68.00 ea
1970	V-8 All 455 C.I.	1-Q-70	W3342701.....	\$68.00 ea
1971	V-8 All 350 C.I.	3-Q-70	W3338703.....	\$68.00 ea
1971	V-8 All 350 C.I.	1-Q-71	W3338711.....	\$68.00 ea
1971	V-8 All 455 C.I.	3-Q-70	W3342703.....	\$68.00 ea
1971	V-8 All 455 C.I.	1-Q-71	W3342711.....	\$68.00 ea
1972	V-8 All 350 C.I.	3-Q-71	W3340713.....	\$68.00 ea
1972	V-8 All 350 C.I.	1-Q-72	W3340721.....	\$68.00 ea
1972	V-8 All 455 C.I. Exc HEI	3-Q-71	W3344713.....	\$68.00 ea
1972	V-8 All 455 C.I. Exc HEI	1-Q-72	W3344721.....	\$68.00 ea
<b>6 Cylinder (V-6)</b>				
1962	V-6 All	3-Q-61	W3210613.....	\$68.00 ea.
1962	V-6 All	1-Q-62	W3210621.....	\$68.00 ea.
1963	V-6 All	3-Q-62	W3210623.....	\$68.00 ea.
1963	V-6 All	1-Q-63	W3210631.....	\$68.00 ea.
1964	V-6 All	3-Q-63	W4012633.....	\$68.00 ea.
1964	V-6 All	1-Q-64	W4012641.....	\$68.00 ea.
1965	V-6 All	3-Q-64	W4012643.....	\$68.00 ea.
1965	V-6 All	1-Q-65	W4012651.....	\$68.00 ea.
1966	V-6 All	3-Q-65	W4012653.....	\$68.00 ea.
1966	V-6 All	1-Q-66	W4012661.....	\$68.00 ea.
1967	V-6 All	3-Q-66	W4012663.....	\$68.00 ea.
1967	V-6 All	1-Q-67	W4012671.....	\$68.00 ea.

## Stoplight Switch

1961-1963 All.

SLS-563.....\$8.50 ea.

1964-1972

1964-1972: All;

1971-1972: All except Cruise control.

SLS-645.....\$7.25 ea.

1971-1972 All with Cruise control.

SLS-715.....\$8.25 ea.

## Air Conditioning

### Blower Relay

1969-1972 All.

ACR-652.....\$16.50 ea.

# Electrical ( Group 2 )

## Generators (Rebuilding Service)

1961-1962 All.  
G-612 .....\$97.50 ea.

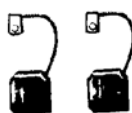

1961-1962 Generator Brush set.  
GBS-607 .....\$4.50 set  
1961-1962 Generator front bearing.  
GEB-412 .....\$11.00 ea.

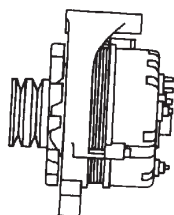

## Alternators

1963-1971 All 61 AMP.  
A-631 .....\$64.75 ea.

## Alternator Fan (2.274)

Genuine replacement.  
Cadmium plated.

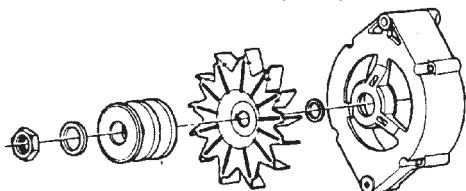

1963-1972  
1963-1965: All except 62 AMP;  
1967-1972: All.  
AF-585 .....\$13.75 ea.

## Alternator Brace/Adjuster (2.317)

1969-1970 All 400, 455 engines. (oem # 1387139)  
AB-690 .....\$19.00 ea.  
  
1971-1972 All 455 engines. (oem #)  
AB-72 .....\$19.00 ea.

## Voltage Regulators

1961-1962 All with generator, without air conditioning.  
VR-572 .....\$45.00 ea.  
1961-1962 All with generator, with air conditioning.  
VR-582A .....\$50.50 ea.  
1962-1972 Delco alternator regulator. All except Heavy Duty 62, 80 AMP Jobs.  
VR-622 .....\$59.50 ea.  
VR-622D.....Genuine Delco.....\$79.50 ea.  
VR-622E.....Electronic Replacement.....\$23.00 ea.  
1965-1972 All with Heavy Duty 62-80 AMP alternators.  
VR-655 .....\$55.00 ea.

## Alternator Parts

1963-1971 All. Alternator front bearing.  
GEB-581 .....\$14.75 ea.  
  
1972-1973 All. Alternator front bearing.  
GEB-723 .....\$11.00 ea.

## Alternator Contact Rubber Boot

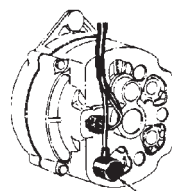

1963-1972 All.  
AB-632 .....\$4.00 ea.

## Distributors

(Rebuilding Service)

1961-1963 All V-8.  
D-613 .....\$85.75 ea.  
  
1962-1965 All V-6.  
D-625 .....\$89.00 ea.  
  
1964-1967 300 engine.  
D-647 .....\$104.25 ea.  
  
1965-1966 GS 400.  
D-596 .....\$89.00 ea.  
  
1966-1967 All V-6.  
D-667 .....\$89.00 ea.  
  
1966-1967 340 engines.  
D-667 .....\$89.00 ea.  
  
1967-1972  
1967 400: engines;  
1968-1972: All.  
D-674 .....\$90.25 ea.

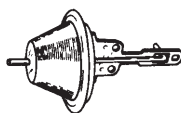
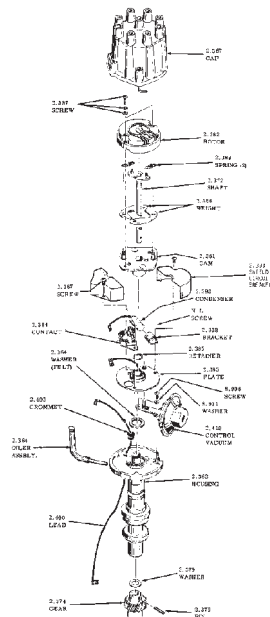

## Distributors Vacuum Controls

1961-1970 All. Oem replacement  
VC-600 .....\$13.75 ea.  
1961-1970 All. Adjustable  
VC-600A .....\$24.50 ea.  
1971-1974 All 455 engines except Stage 1.  
VC-714 .....\$13.75 ea.  
1971-1974 All 350 engines and 455 Stage 1.  
VC-724 .....\$13.75 ea.

# Electrical (Group 2)

## Genuine Guide T-3 Headlight Bulbs

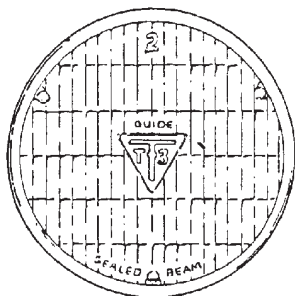

1961-1967 All.  
SB-607S .....\$124.50 set of 4

1968-1971 All.  
SB-681S .....\$124.50 set of 4

### Headlamp Switches

1961-1963 All.  
HS-593.....\$52.25 ea.

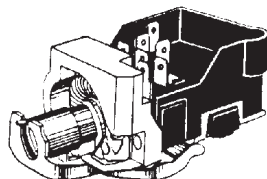

1964-1967 All.  
HS-647.....21.50 ea.  
HC-645.....(connector plug for above).....\$35.75 ea.

1968-1972 All.  
HS-685.....\$24.75 ea.  
HC-645.....(connector plug for above).....\$35.75 ea.

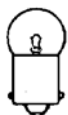

## Bulbs

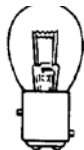

## Headlamp Dimmer Switches



1961-1972 All Exc. Guidematic.  
HDS-615.....\$8.75 ea.  
1964-1972 All with Guidematic.  
HDS-642.....\$19.50 ea.

## Headlamp Door Screw Set

Set of 8. Correct chrome plated with small head.  
HS-702.....\$5.25 set

## Headlamp Nuts & Pads



1964-1966 All. Headlamp Bezel retaining Nut  
HBN-649.....\$2.00 ea.

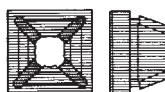

1963-1968 Headlamp Body and Beam  
Adjusting Nut  
HN-634 .....\$1.25 ea.



1969-1972 Headlamp Bezel retaining nut.  
HBN-692.....\$2.00 ea.

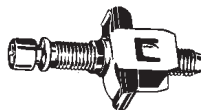

1969-1972 Headlamp Adjusting Nut and  
Screw.  
HN-694 .....\$3.50 ea.



1970-1972 Headlamp Assembly to core  
support Pads. White nylon. 12 per car.  
HP-705 .....\$2.00 ea.  
HP-705S.....(Set of 12).....\$20.00 set

Year & Model	Head-light	Parking	Direction Signal		Tail	Stop	License Plate	Instru-ment	Indi-cator	Dome	Back-up	Marker lamp	
			Front	Rear								Left	Right
1961	SB1, SB2	B-1034	B-1034	B-1034	B-1034	B-1034	B-67	B-194-1816	B-194	B-211	B-1073	----	----
1962	SB1, SB2	B-1034	B-1034	B-1034	B-1034	B-1034	B-67	B-194-1816	B-194	B90-211	B-1073	----	----
1963	SB1, SB2	B-1034	B-1034	B-1034	B-1034	B-1034	B-67	B-194	B-194	B90-1004	B-1073	----	----
1964	SB1, SB2	B-1157	B-1034	B-1157	B-1157	B-1157	B-97	B-194	B-194	B90-211	B-1156	----	----
1965	SB1, SB2	B-1157A	B-1157A	B-1157	B-1157	B-1157	B-97	B-194	B-194	B90-211	B-1156	----	----
1966	SB1, SB2	B-1157A	B-1157A	B-1157	B-1157	B-1157	B-97	B-194	B-161	B90-211	B-1156	----	----
1967	SB1, SB2	B-1157A	B-1157A	B-1157	B-1157	B-1157	B-97	B-194	B-161	B-211	B-1156	----	----
1968	SB1, SB2	B-1157A	B-1157A	B-1157	B-1157	B-1157	B-97	B-194-1893	B-194	B-90-1004	B-1157	B-194A	B-194
1969	SB1, SB2	B-1157A	B-1157A	B-1157	B-1157	B-1157	B-97	B-194-1893	B-194	B-90-1004	B-1157	B-194A	B-194
1970	SB1, SB2	B-1157A	B-1157A	B-1157	B-1157	B-1157	B-97	B-194-1893	B-194	B-90-211	B-1157	B-194A	B-194
1971	SB1, SB2	B-1157A	B-1157A	B-1157	B-1157	B-1157	B-97	B-194-1893	B-194	B-90-211	B-1157	B-194	B-194
1972	SB1, SB2	B-1157A	B-1157A	B-1157	B-1157	B-1157	B-97	B-194-1893	B-194	B-90-211	B-1157	B-194	B-194

Prices: SB-1 & SB-2-\$10.00, 53-\$1.50, 57-\$1.25, 67-\$1.50, 90-\$2.00, B-97-\$2.00, 161,168-\$2.00, 181-\$1.75, 194-\$2.00, 194A-\$2.75, 210-\$5.25, 211-\$2.00, 1004-\$2.50, 1034-\$2.50, 1073-\$2.50, 1156-\$2.25, 1157A-\$3.25, 1157-\$2.25, 1816-\$2.00, 1893-\$2.00.

# Electrical (Group 2)

## 1965 Skylark & GS Parking Lamp Lens



PL-65S.....(Fits Either Side).....\$69.50 ea.

## 1968-1969 Front Parking Lamp Gaskets

PLG-689.....\$9.50 pair

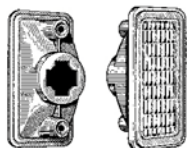

## Side Body Marker Lights

1968-1969 Left & Right Front Marker Lens.

MLF-689 .....\$16.00 ea.

## Marker Lamp Gaskets

1968-1969 Front or Rear

MLG-689.....\$3.75 ea.

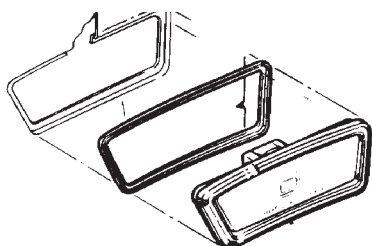

## 1970-1972 Front and Rear Marker Lamps & Gaskets

### Marker Lamps:

ML-702F .....Front Amber .....\$99.00 pr.

ML-702R.....Rear Red.....\$99.00 pr.

ML-702S.....Front and Rear .....\$189.00 set of 4.

### Gaskets:

(Manufactured to be identical to originals)

MG-702S .....Set of 4 .....\$29.00 set

MG-702F .....Front Only.....\$15.00 pr.

MG-702R.....Rear Only .....\$16.00 pr.

Same as above but flat rubber replacements

MLG-702F .....Front Markers .....\$6.00 pr.

MLG-702R .....Rear Markers .....\$6.00 pr.

## 1965 Tail Lamp Gasket Set

1965 All. Eight piece set, inner and outer.

TLG-65S.....\$32.00 set

## 1967 Tail Lamp Gaskets

TLG-67S.....(lens to housing).....\$14.50 pr.

TLM-67S.....(lamp to body).....\$12.50 pr.



## 1968-1969 Tail Lamp Gaskets

TLG-689.....\$9.50 pr.

## 1970-1972 Tail Lamp Lenses & Gaskets

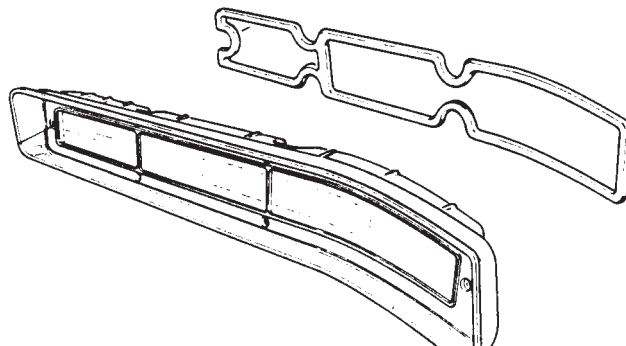

## 1970 Tail Lamp Lens (Fits either side)

TL-70.....\$89.00 ea.

TLG-702.....Gaskets for Above.....\$9.50 pair

## 1971 Tail Lamp Lenses

TL-71L.....(Fits L.H. Side).....\$109.00 ea.

TL-71R.....(Fits R.H. Side).....\$109.00 ea.

TLG-702.....Gaskets for Above.....\$9.50 pair

## 1972 Tail Lamp Lenses

TL-72L.....(Fits L.H. Side).....\$109.00 ea.

TL-72R.....(Fits R.H. Side).....\$109.00 ea.

TLG-702.....Gaskets for Above.....\$9.50 pair

## 1972 Rear Tail Lamp Cushions



An excellent reproduction of the Rubber tail lamp cushions used on 1972 Skylark & GS models. (7.831)

TLC-72L.....(Left Side).....\$180.00 ea.

TLC-72R.....(Right Side).....\$180.00 ea.

TLC-72.....(Both Sides).....\$350.00 pr.

## 1961 Tail Lamp Lenses

1961 Special 4-Door Sedan Models.

TL-61SL.....Left Hand Side.....\$20.00 ea.

TL-61SR.....Right Hand Side.....\$20.00 ea.

# Electrical (Group 2)

## 1963 Back-up Lens

1963 all. Genuine Guide. Fits either side.

BL-63S .....\$16.50 ea.

## 1967 Back-up Lamp Gasket

1967 all except wagons.

BLG-67S.....\$4.50 ea.

## License Plate Parts

**1961-1962** License Lamp Gasket Set.

LG-462 .....\$7.50 set

**1968-1972** License Lamp Lens Assembly.

LLA-682.....\$38.50 ea.

**1964-1972** License Lamp Gasket . (2.707)

LLG-643.....\$6.50 ea.

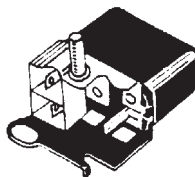

**Horn Relays** (2.815)

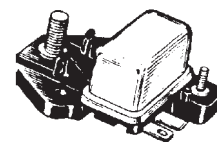

**1961-1967** All with junction block.

HR-617 .....\$47.50 ea.

**1965-1968** All (relay only).

HR-658 .....\$9.25 ea.

**1969-1972** All.

HR-693 .....\$11.00 ea.

## Directional Signal Switch (2.895)

**1964-1966** All with tilt wheel. Includes wiring.

DSS-646T.....\$79.50 ea.

**1965-1966** All w/o tilt wheel. Stamped "guide".

Includes wiring.

DSS-656 .....\$79.50 ea.

## Signal Flasher

1961-1972 All.

SF-615.....\$4.00 ea.

