

Starter Rebuilding Service

Does Not Include Solenoid

- 1934-1938 Special.**
- S348.....\$194.50 ea.
- 1936-1938 Series 60-80-90.**
- S368.....\$194.50 ea.
- 1939-1950**
- 1939: Special;
- 1940-1950: Special and Super.
- S390.....\$199.50 ea.
- 1939-1950 Roadmaster.**
- S390B.....\$194.50 ea.
- 1951-1953**
- 1951-1952: Special and Super;
- 1953: Special.
- S513.....\$194.50 ea.
- 1951-1952 Roadmaster.**
- S512.....\$194.50 ea.
- 1953 Super and Roadmaster.**
- S53.....\$194.50 ea.
- 1954-1956 All.**
- S546.....\$194.50 ea.
- 1957-1958 All.**
- S578.....\$189.50 ea.
- 1959-1960 All.**
- S590.....\$189.50 ea.

Starter ID Tag

1931-1960 Delco, starter, gen., and distributor ID tag.



- ET6.....(ALL 6 VOLT).....\$7.00 ea.
- ET12.....(ALL 12 VOLT).....\$7.00 ea.

Starter Brush Sets

- 1935-1952; 1953 Series 40.**
- SBS353.....\$5.50 set
- 1953-1960 All V-8.**
- SBS539.....\$6.50 set



Starter Solenoid Boots



- 1934-1950 All.** Solenoid boot. Cover on starter motor solenoid. (2.140)
- SB420.....\$7.50 ea.



- 1951-1956 Starter solenoid boot.**
- SB516.....\$11.25 ea.

Starter Solenoids (2.100)



- 1934-1941 All.** (Rebuilding Service).
- SS341.....\$189.00 ea.
- 1942-1950 All Engines.** (Rebuilding Service).
- SS420.....\$124.50 ea.
- 1951-1953**
- 1951-1952: Special and Super;
- 1953: Special. (Sold Outright).
- SS513.....\$104.50 ea.
- 1953 All V-8 Engines.** (Rebuilding Service).
- SS53.....\$95.50 ea.
- 1954-1956 All.** (Sold Outright).
- SS546.....\$64.50 ea.
- 1957-1960 All.** (Sold Outright).
- SS575.....\$38.50 ea.

Starter Solenoid Repair Kit



- 1957-1960 All.**
- SRK570.....\$24.50 kit

Starter Drives



- 1932-1953**
- 1932-1952: All;
- 1953: Specials.
- SD393.....\$48.00 ea.
- 1953 All V-8.**
- SD53.....\$49.50 ea.
- 1954-1956 All.**
- SD546.....\$41.00 ea.
- 1957-1960 Starter drive.**
- SD571.....\$57.00 ea.

Starter Relay (2.127)

- 1932-1953 All V-8 engines.** (12V)
- Aftermarket replacement
- SR530.....\$58.50 ea.

Horn Contact Separator

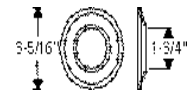





- 1938-1949 Special; 1940 Super.**
- HS389.....\$29.75 ea.

Starter Motor End Bushings

- 1931-1952 Series 60, 70, 80, 90 - drive end.**
- SB282D.....\$3.75 ea.
- 1931-1952 Series 60, 70, 80, 90 - center.**
- SB282C.....\$3.00 ea.
- 1931-1952 Series 40, 50; 1953 Series 40 - drive end.**
- SB313D.....\$3.75 ea.

Ignition Parts (Group 2)

Years	POINT SET (2.384) 	CONDENSER (2.393) 	DIST. CAP (2.367) 	ROTOR (2.382) 	IGNITION COIL (2.170) 	COMPLETE TUNE UP KITS 8 Spark Plugs, Points, Rotor, Condenser, Cap, Wire Set. Complete \$89.50
1937-1950	D103.....\$11.50	D203...\$6.00	D302..\$16.50	D401...\$8.00	IC373...\$26.50	TK370
1951-53 ex.	D103.....\$11.50	D203...\$6.00	D302..\$16.50	D401...\$8.50	IC373...\$26.50	TK513
1953 (12 vt.)	D104.....\$13.50	D203...\$6.00	D305..\$16.50	D403...\$16.50	IC539...\$26.50	TK536
1954-1956	D104.....\$13.50	D203...\$6.00	D305..\$16.50	D403...\$16.50	IC539...\$26.50	TK536
1957-1960	D106.....\$16.50	D204...\$6.00	D308..\$13.50	D409...\$7.50	IC539...\$26.50	TK579

Spark Plugs (2.270)



SP86	1929-1937 All	\$2.95 ea.
SP45R	1938-1942 All	\$2.95 ea.
SP45R	1946-1949 All	\$2.95 ea.
SP45R	1950-1952; All 1953 Ser 40	\$2.95 ea.
SP45R	1953-1957 All V-8 (use #45)	\$2.95 ea.
SP45R	1958 All	\$2.95 ea.
SPR43S	1959-1960 All	\$2.95 ea.

Spark Plug Boots



SB536	1953-1956 All V-8.	\$3.00 ea.
SB577	1957-1960 Spark plug boots (8 per car). Use with original type copper core ignition wires.	\$3.00 ea.

Delco Ignition Points

1937-1953 Original Delco Igniton Points.

IP373N	\$21.50 ea.
1953-1956 All V-8 Original Delco Ignitions Points.	
IP536N	\$21.50 ea.

Original Ignition Lock Cylinder With 2 Keys

1935-1939 All

IL359	\$19.50 ea.
1941-1953:	
1941-1950: All; 1951-1953: Super, Roadmaster and Skylark.	
IL413	\$52.50 ea.
1951-1953 Specials; 1954-1956 Same	
IL513	\$28.00 ea.
1957-1960 All	
IL359	\$19.50 ea.
1941-1960 All, replacement type. (non original).	
IL414	\$26.00 kit



Key Blanks-Genuine GM



1933-1960 Octagon.	
KB10	\$3.50 ea.
1933-1960 Rounded.	
KB11	\$3.50 ea.

KB10 KB11

Spark Plug Wire Sets



(2.239)

1936-1952 All; 1953 Series 40.

1953-1956 All V-8.

IW366S	\$42.75 set
1957-1960 All.	
IW576	\$29.50 set

Spark Plug Wire Grommets, etc.



1936-1953 All Straight-8 spark plug wire retainers. 4 piece set.
WR363.....\$27.50 set

1953 Oblong for spark plug wire clip at right rear head. Uses two per car. Series 50 and 70.
WG53C\$18.50 pr

1953 Trapezoidal style under spark plug cover flange at right end of both sides. One pair per car. Series 50 and 70.
WG53.....\$9.50 ea.

1954-1956 (4 per car).
WG546.....\$7.50 ea.

1957-1958 (4 per car).
WG578.....\$4.95 ea.

1959-1960 Ignition wire retainer.
WR596.....\$4.25 ea.

Distributor Adjusting Tool

1957-1960 All .

DT575.....\$10.00 ea.



Distributor Vacuum Advance Controls

1961-1974 All. Oem replacement.

VC600.....\$16.25 ea.



Universal Coil Bracket

With mount for Radio Capacitor

CB350	\$6.50 ea.
CB350C.....Chrome	\$11.50 ea.





www.oldbuickparts.com

Never Change Points Again!

Upgrade to an electronic ignition. Fits entirely inside the distributor.
 Installs as quickly as changing a set of points. No black boxes,
 complicated wiring or special brackets. Only two wires to connect.

IGNITOR ELECTRONIC IGNITION KITS	NO.	PRICE
8 CYLINDER		
1937-1953 All Straight 8, 6 volt, negative ground	PI1183N6	\$119.75
1937-1953 All Straight 8, 12 volt, negative ground (original distributor)	PI1183	\$109.25
1953-1956 All V-8 Mechanical advance under baseplate	PI1185LS	\$89.50
1957-1974 All V-8 Except 215, 300, 340 Engines	PI1181LS	\$89.50
1957-1974 All V-8	PI1181	\$89.50
1957-1974 All V-8 (Ignitor II)	PI91181	\$109.50
6 CYLINDER		
1968-1974 All	PI1162A	\$89.50
1962-1967 V-6 Engine.....	PI1164	\$89.50
1962-1967 V-6 Engine (Odd Fire)	PI1165	\$89.00
HIGH PERFORMANCE COIL		
1937-1953 All Straight 8, 6 volt, negative ground (Black)	PC45011	\$39.50
1937-1953 All Straight 8, 6 volt, negative ground (Chrome)	PC45001	\$49.50
1953-1974 All (Black)	PC40011	\$37.50
1953-1974 All (Chrome) 12 v	PC40001	\$46.50
1953-1974 All (For Ignitor II applications only - Chrome) 12 v	PC45001	\$49.50
1953-1974 All (For Ignitor II applications only - Black) 12 v	PC45011	\$39.50
Coil Bracket	CB350	\$6.50
Coil Bracket (Chrome)	CB350C	\$11.50
HIGH PERFORMANCE SPARK PLUG WIRES		
Low 500 ohm/ft. resistance with spiral wound alloy to suppress electromagnetic radiation plus redundant current paths.		
V-8 7.0mm Stock-Look Custom Set		
1953-1960 All	PW708103	\$44.50
1960-1967 Special, Skylark, GS (Ex 1967 GS 400).....	PW708103	\$44.50
1967-1966 LeSabre, Wildcat, Invicta, Electra, Riviera All 364, 401, 425 Engines	PW708105	\$44.50
1967 GS-400	PW708102	\$44.50
1968-1974 All 350, 400, 430, 455 w/o HEI.....	PW708102	\$44.50
6 CYLINDER 7.0mm STOCK-LOOK Custom Set		
1968-1974 ALL	PW706101	\$44.50

Ignition Parts (Group 2)

Battery Cable Covers (2.343)

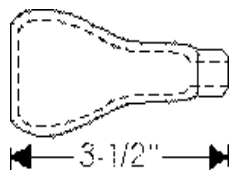

1931-1960 Battery cable cover. Two per car.
CC315\$6.25 ea.

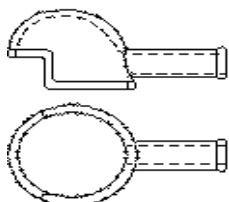

1932-1960 All. Battery cable cover. Located on switch side and junction block. (Two per car).
CC325\$6.25 ea.

Battery Cables

Ground Cables (-) (2.341)

BC9	1931-1932 All; 1933 series 60,80,90; 1934-1935 Series 40, 60, 90; 1936-1937 All; 1950-1951 Special and Super; 1953 Special.....	\$12.25 ea.
BC13	1933-1935 Series 50; 1938-1949 All; 1950-1952 Roadmaster.....	\$15.25 ea.
BC19	1953 Ser. 50-70; 1954-56 ; 1958-60	\$17.50 ea.
BC24	1957	\$19.50 ea.



Switch Cables (+) (2.342)

BC48	1933-1937 All	\$34.50 ea.
BC17	1938-1953 All Straight 8; 1958-1960 All	\$16.50 ea.
BC14	1953 All V-8 engines; 1957 All	\$17.00 ea.
BC19	1954-1956 All.	\$17.50 ea.



See Wire Loom, page 25 cover some battery cables.

Switch to Starter Cable

1953-1960

	1953-1956 : All; 1959-1960 : All.	
SC32		\$27.75 ea.



Battery Hold Down Clamps (2.335)



1932-1937 All series 40 and 50.
BC327\$34.50 ea.



1939-1949 All with shield.
BC399\$59.00 ea.



1939-1953 All straight 8 w/o shield.
BC393\$37.50 ea.



1955-1957 All.
BC557\$59.00 ea.



1960 All. Rubber coated as original.
BC602\$39.50 ea.

Battery Parts (9.775) 2 per car



1939-1953
1939-1952: All;
1953: Series 40 Battery hold down.
Grommet.
BG393\$3.00 ea.



1953-1958 Battery cushion. Attaches to battery hold. (4 per car).
BC548\$2.75 ea.

Battery Top Louvre



1953 Super, Roadmaster and Skylark.
BL53\$49.50 ea.

Battery Hold Down Bolts (2.334)



1939-1953 All. Battery hold down kits. Kit contains 2 bolts, 2 grommets, 2 wing nuts, and 2 washers.
BK393\$12.25 set

1954-1958 All. Battery hold down kits. Kit contains 2 bolts, 2 washers, 2 wing nuts, 4 (BC548) cushions.
BK548\$17.25 ea.

1960 All, two needed per car. Includes washer and wing nut.
BB602\$6.50 ea.



Generator Rebuilding Service

G356	1935-1936 Special and Super	\$266.75
G36	1936 Series 60, 80, and 90.....	\$266.75
G37	1937 Special	\$266.75
G3B	1937 Series 60, 80, and 90.....	\$266.75
G389	1938-1939 All.....	\$266.75
G409	1940-1948 All; 1949 Special.....	\$189.50
G491	1949 Super and Roadmaster; 1950-1951 All.....	\$189.50
G523	1952 All; 1953 Special	\$189.50
G536	1953-1956 All V-8	\$189.50
G57	1957 Without air conditioning	\$189.50
G57A	1957 All with air conditioning	\$189.50
G58	1958 Without air conditioning	\$189.50
G58A	1958 All with air conditioning	\$189.50
G59	1959 Without air conditioning	\$189.50
G59A	1959 All with air conditioning	\$189.50
G602	1960 Without air conditioning	\$189.50
G60A	1960 All with air conditioning	\$189.50

Generator Brush Sets (2.285)

Part No.	Years	
 GBS359	1935-1939 All.....	\$10.25 set
GBS401	1940-1951 All.....	\$5.75 set
GBS527	1952-1957 All.....	\$5.75 set
GBS401	1958-1960 All.....	\$5.75 set

Generator Bearings (2.306)

1941-1960 Generator front bearing.	
GEB412.....	\$8.75 ea.
1934-1952 Generator com. end bushing.	
GEB302.....	\$5.00 ea.
1954-1957 Generator rear bearing. (2.298)	
GEB547	\$17.75 ea.
1958-1960 Generator rear bearing.	
GEB581	\$15.75 ea.

Generator Pulley (2.274)

1957-1960 All without air conditioning. Single Pulley.	
AP575.....	\$33.25 ea.



Generator Fan (2.274)

1958-1960 All. (Correct cadmium plating).	
AF585.....	\$17.50 ea.

Generator I.D. Tag



1931-1960 Delco, starter, generator and distributor ID tag.

ET6.....(ALL 6 VOLT).....	\$7.00 ea.
ET12.....(ALL 12 VOLT).....	\$7.00 ea.

Voltage Regulators (2.500)



1940-1953 All 6 volt replacement.

VR403	\$94.50 ea.
1953-1956 All, 12 volt replacement.	
VR536	\$79.50 ea.
1957-1960 1957 All ;1958-1960 All with out A.C.	
VR572	\$59.50 ea.
1958-1960 All with A.C. - replacement.	
VR582A	\$79.50 ea.

Voltage Regulator Cover "Delco Remy"

1940-1960 All "Delco Remy"

VRC402.....	\$32.50 ea.
-------------	-------------



Coil Resistor

1953-1960 Coil resistor on firewall.

CR533.....	\$11.50 ea.
------------	-------------

Horn Relay (2.815)



1937-1953 All six volt replacement horn relay.

HR373	\$17.00 ea.
1953-1956 All V-8.	
HR536	\$21.50 ea.
1957-1958 All.	
HR578	\$13.25 ea.
1959-1960 All.	
HR590	\$79.75 ea.

Electrical (Group 2)

Delco Ignition Points

1937-1953 Original Delco Ignition Points.
 IP373N\$10.25 ea.
1953-1956 All V-8 Original Delco Ignition Points.
 IP536N\$14.00 ea.

Distributor Adjusting Tool

1957-1960 All.
 DT575\$10.00 ea.



Universal Coil Bracket

With mount for Radio Capacitor.
 CB350\$6.50 ea.
 CB350C.....Chrome\$11.75 ea.

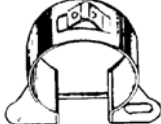

Distributor Rebuilding Service (2.361)

1934-1953
 1934-1952: All;
 1953: Special.
 D343\$209.50 ea.
1954-1958 All. Does not include vacuum.
 D548\$167.50 ea.
1959-1960 All.
 D596\$167.50 ea.

Distributor Vacuum Control Rebuilding Service (2.410)

1937-1952 All.
 VC372RS\$66.00 ea.
1953 Special.
 VC53RS\$66.00 ea.
1953 Super, Roadmaster, Skylark; **1954-1956** All.
 VC536RS\$66.00 ea.
1957-1959 All.
 VC579RS\$66.00 ea.

1960 All. Sold outright.
 VC600\$16.25 ea.



Electronic Distributor



Now available for the Vintage Buick Straight 8 is the high performance DUI Distributor! This high powered ignition will light the fire in the straight 8 like never before. Built with our popular Street Strip DUI Coil, you can open the plug gaps to a massive .055"! Also included is the high dwell Dyna-Module

which allows the coil to produce a longer duration spark over stock ignitions. The advance curve is custom tuned to provide the most power throughout the RPM range with no pre-detonation. Additional benefits are quicker starting, smoother idle and it is all electronic - NO POINTS! Installation is easy with only one wire required for hookup. Bring your straight 8 up to date by adding some serious firepower with the DUI! Comes with easy to follow instructions and is backed by a one year warranty.

- Simple One Wire Hookup
- Allows for Wider Plug Gaps
- All Electronic Ignition - No Points
- 50,000 Volt Coil and Dyna Module
- Performance Tuned Advance Curve
- Increased Horsepower and Fuel Mileage

1936-1953 (12 volt only) 248, 263, 320 engines.
 DUI383\$395.00 ea.
 State cap color: Black, Red, Blue.

Live Wires



IW383B.....(Black).....\$99.00 ea.*
 IW383R.....(Red).....\$99.00 ea.*
 IW383U.....(Blue).....\$99.00 ea.*

* For use with DUI383 ONLY.

Headlamp Doors (Rims) (2.728)

- 1940** All. stainless steel. Perfect reproduction.
 HD40.....\$49.75 ea.
1940 All. Completely assembled with our HR407 rubber seal and HC402 clips.
 HD40A.....\$59.75 ea.
1941 All. Headlamp door.
 HD41.....\$23.25 ea.
1942-1948 All. Headlamp door.
 HD428.....\$26.50 ea.
1942-1948; 1949 Special Headlamp spear.
 HS429.....\$10.50 ea.
1949-1952 Headlight door. Stainless steel.
 HD492.....\$44.50 ea.

Headlamp Mounting Ring

- 1940-1954** All; **1955** First Type.
 HMR405.....\$27.50 ea.

Headlamp Bucket Assembly

- 1949-1952** All. Less Bulb.
 HB492.....\$94.50 ea.

Headlamp Retainers

- 1940-1954** All;
1955 First type.
 Chrome plated. Beautiful!
 HR405.....\$27.50 ea.
1956-1957 All.
 HR567.....\$27.50 ea.
1940-1960 Retainer screw.
 HS400.....\$1.25 ea.

Headlamp Seals

- 1940-1957**
1940 All;
1949 Super & Roadmaster;
1950-1957 all except 1955.
 HB407.....\$12.75 pr.
1941-1949. (For 9" dia. seals)
1941-1948 All;
1949 Specials.
 HB419.....\$14.50 pr.
1955 All.
 HB55.....\$23.50 pr.

Headlamp Bucket Grommet

- 1940 thru 1957** All.
 BG407.....\$5.75 ea.

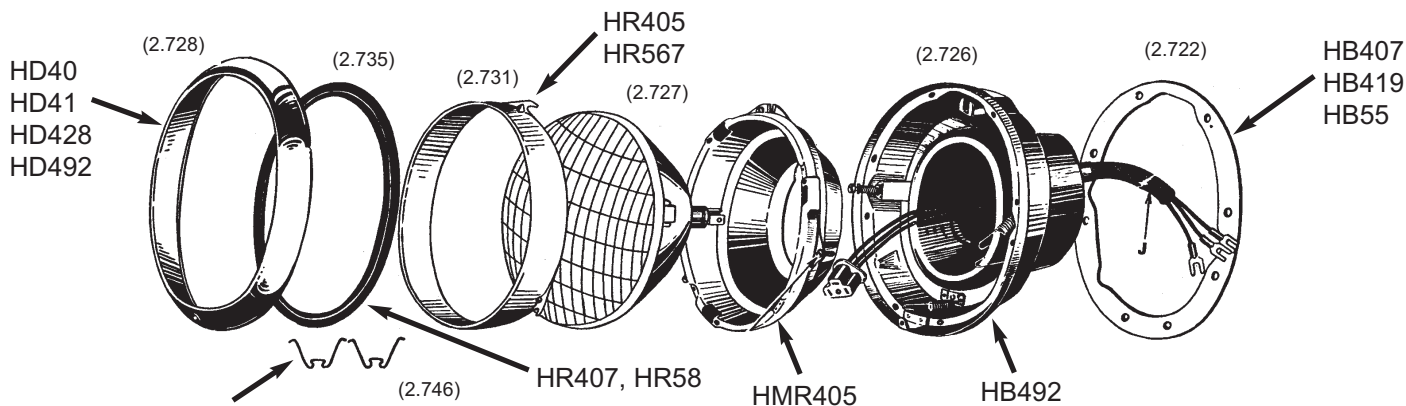

- 1936-1939** All. Headlamp retaining clips. 3 clips per set. Stainless steel. 2 sets per car.
 HC369.....\$5.50 set

- 1940-1952** All. Headlamp rim seal retaining clips. 4 clips per set. Stainless steel. Two sets per car.
 HC402.....\$6.25 set

- 1940-1957** Headlamp door seals. Smooth rubber skin with inner seal core for perfect fit.
 HR407.....\$18.50 pr.

- 1958** All.
 HR58.....\$34.25 pr.

- 1958-1960** All;
 Headlamp adjusting screw assembly.
 HA582.....\$3.50 ea.



- 1958** All.
 Headlamp to fender seals.
 HB58.....\$57.50 pr.

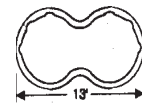

"Guide" Genuine T-3 Headlamps (2.727)

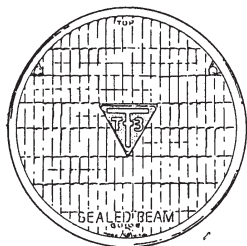

1956-1957
 Two Hi/Low Beams.
 SB567S.....TOS



1958-1959
 Two Hi/Low Beams
 Two Hi Beams.
 SB589S.....TOS

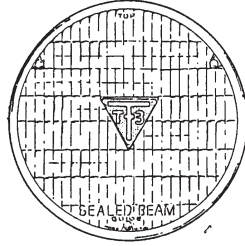

1960
 Two Hi/Low Beams
 Two Hi Beams.
 SB607S.....\$149.00 set

Replacement Sealed Beams (2.727)

- 1940-1953** Headlamp sealed beam, 6 volt. (Halogen)
 SB6.....\$12.50 ea.

- 1953-1957** 12 volt.
 SB12.....\$11.00 ea.

- 1958-1960** All. Headlamp sealed beam. #1, high beam. Two terminals.
 SB1.....\$11.00 ea.

- 1958-1960** All. Headlamp sealed beam. #2, low beam. Three terminals.
 SB2.....\$11.00 ea.

Headlamps and Parts (Group 2)

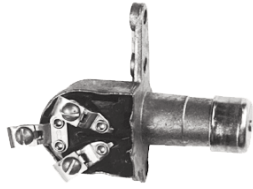

Headlamp Dimmer Switches

1934-1958

1934-1956 All;

1957-1958 All, except with Autronic Eye.

HDS348.....\$19.50 ea.

1959-1960 All, except with Autronic Eye.

HDS590.....\$24.50 ea.

Headlamp Terminal Junction Blocks



1936-1939 (6 prongs).

JB369.....\$21.50 ea.

1940-1951 (8 prongs).

JB401.....\$19.50 ea.



1952-1955

JB525.....\$21.00 ea.

Headlamp Mounting Pads



1934-1935 For 3 1/4" x 6 1/4" base, non-symmetrical. Series 50, 60 and 90.

HLP345B.....\$60.50 pr.

1934-1935 Headlight bracket to fender. Right and left. Series 40.

HLP345.....\$35.00 pr.

1936 All series.

HLP36.....\$33.50 pr.

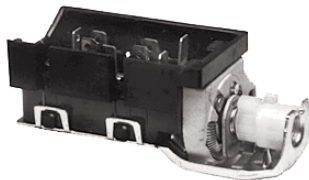

Headlamp Switches

1949-1953 All 6 volt aftermarket replacement type.

HS493.....\$49.50 ea.

1959-1960 All. OEM replacement type.

HS593.....\$49.50 ea.

Wire Loom

Asphalt coated fabric. Wire loom for battery cables, headlamps, wire etc.



WL1801/8" ID\$1.85 ft.

WL3163/16" ID\$1.85 ft.

WL1401/4" ID\$2.10 ft.

WL5165/16" ID\$2.10 ft.

WL3803/8" ID\$2.10 ft.

WL7167/16" ID\$2.10 ft.

WL1201/2" ID\$2.10 ft.

WL9169/16" ID\$2.40 ft.

WL5805/8" ID\$2.40 ft.

WL3403/4" ID\$2.40 ft.

Woven Wire Mesh Split Loom



WWL3163/16" ID\$1.75 ft.

WWL3803/8" ID\$2.00 ft.

WWL1201/2" ID\$2.50 ft.

WWL3403/4" ID\$3.00 ft.

WWL1001" ID\$3.50 ft.

Headlamp Wiring Grommets



1936 Grommet, headlight wiring from headlight bulb through mounting brace.

Series 40.

WG36.....\$27.25 pr.



1936-1941 Electric wire through body for head and tail lights. 3/8" I.D. for 11/16" hole.

WG361.....\$2.25 ea.

New Xenon Headlamp Technology for Your Old Buick

One of the weakest systems in older cars is the quality of lighting. Night driving is particularly unsafe due to low levels of candlepower. Modern technology has developed state of the art **Xenon Head-lamps** now available for your model Buick.



1940-1953

Two Hi/Low 6V

Haolgen Beams.

SB6H...\$86.50 set

1953-1957

Two Hi/Low

Xenon 12V Beams.

SB12X...\$49.50 set



1958-1960

Two Hi/Low Beams

Two Hi Beams Xenon

SBXs.....TOS

Park Lamp Pads



1936 All. Parking lamp mounting pads.
PLP36.....\$42.25 pr.



1937 All. Parking lamp mounting pads.
PLP37.....\$34.50 pr.



1938 All. Parking lamp mounting pads.
PLP38.....\$33.00 pr.

1939 All. Parking lamp mounting pads.
PLP39.....\$36.50 pr.

1940 All. Parking lamp mounting pads.
PLP40.....\$47.00 pr.

Front Parking Lamp Lenses



1936 All.
PL36.....\$21.00 ea.



1937-1938 All. Includes gaskets
PL378.....\$29.50 ea

1939 All.
PL39TOS



1941 All.
PL41.....\$39.50 ea.



1946-1949
1946-1948 All;
1949 Specials.
PL469.....\$21.50 ea.



1949 All Super and Roadmaster.
PL49.....\$35.00 ea.



1950-1952 All. "Guide".
PL502.....\$18.00 ea.



1953-1954 All. "Guide".
PL534.....\$18.00 ea.



1955 Special and Century. "Guide".
PL55.....\$18.00 ea.



1955 Super and Roadmaster.
PL55B\$26.50 ea.



1956-1957 All. "Guide".
PL567.....\$24.00 ea.



1958 All. "Guide".
PL58.....\$26.50 ea.



1941 All. Parking lamp mounting pads.
PLP41.....\$72.50 pr.



1942-1948 Super and Roadmaster parking lamp mounting pads.
PLP428.....\$14.50 pr.



1953-1954 All (Lamp to body gasket).
PLP534.....\$9.75 pr.



1936-1938 Replacement. These lamps are quality made but not exact reproductions.
PL300.....\$185.50 pr.

Fender Lights

Front Parking Lens Gaskets



1936-1938 All.
PLG368.....\$5.50 pr.

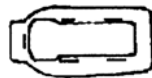

1939 All.
PLG39.....\$5.50 pr.



1941 All.
PLG41.....\$9.75 pr.



1946-1949
1946-1948: All; 1949: Specials.
PLG469.....\$4.50 pr.



1949 Super and Roadmaster.
Four gaskets for two lamps.
PLG49.....\$8.00 pr.



1950-1952 All.
PLG502.....\$5.00 pr.



1953-1954 All.
PLG534.....\$7.00 pr.



1955 All Special and Century.
PLG55.....\$5.75 pr.



1955 Super and Roadmaster.
PLG55B\$11.00 pr.



1956-1957 All.
PLG567.....\$6.00 pr.



1958 All.
PLG58.....\$6.50 pr.



1959 All.
PLG59.....\$22.50 pr.

Parking Lamp Doors



1946-1949
1946-1948 All; 1949 Special.
LD469.....\$29.50 ea.



1950-1952
1950 All; 1951-1952 Super & Roadmaster.
LD50.....\$18.00 ea.



Highly Polished Stainless Steel Screws
LDS503.....\$2.95 ea.

Tail Lamps (Group 2)

Tail Lamp Lenses (2.682)



All Cars; Blue dot glass lenses with chrome ring.
BD360.....\$12.75 pr.

1939-1940 Special & Centruy
Plastic Replacement

TL390.....\$29.50 pr.



1940 Super and Roadmaster. Glass as original.
TL40R.....(R.H. Side).....\$21.50 ea.
TL40L.....(L.H. Side).....\$21.50 ea.

1941 Models 44, 44C, 44S,47;
All Super & Roadmaster.

TL41.....\$91.00 pr.



1942-1948 Super and Roadmaster.
Both sides. Gaskets included.
TL428P.....\$69.50 pr.

1949 Super and Roadmaster.

TL49.....\$29.00 ea.



1950-1952 "Guide".
1950: All;
1951-1952: Super and Roadmaster.
TL502.....\$36.50 ea.

1951-1952 Specials.

TL512.....TOS



1953 All. Four per car. "Guide" imprint. Brass ferrules and deep red color as original. Licensed by GM. Beware of cheap imitations!
TL53.....\$19.50 ea.



1954 All except Skylark. "Guide" imprint. Brass ferrules and deep red color as originals. Four per car. Licensed by GM.
TL54.....\$24.50 ea.



1955 All. "Guide".
TL55.....\$43.50 ea.
S26.....Correct Stainless Screws.....\$1.15 ea.



1956 All. "Guide".
TL56.....\$43.50 ea.



1957 All. Stop lamp lens.
SL57.....\$37.50 ea.



1957 Special and Century.
TL57.....\$36.50 ea.



1959 All. Tail lamp lens.
TL59.....\$43.50 ea.



1960 All. Tail lamp lens.
TL60.....\$43.50 ea.

Tail Lamp Lens Gaskets (2.684)



1936 Tail lamp lens gasket.
TLG36.....\$5.00 pr.

1937 All.
TLG37.....\$6.50 pr.

1938-1940
1938: All;
1939-1940: Series 80-90.
TLG380.....\$7.75 pr.



1939-1940 Special and
Century, Tail lamp lens gasket.
TLG390.....\$7.50 pr.



1942-1948 All.
TLG428.....\$12.50 pr.

1949 Super and Roadmaster,
4 piece tail lamp gasket set.
TLG49.....(For Two Lamps).....\$11.50 pr.



1950-1952
1950: All;
1951-1952: Super and Roadmaster.
TLG502.....\$9.75 pr.

1951-1952 Special.
TLG512.....\$8.00 pr.

1953 All.
TLG53S.....(Set of 4).....\$9.75 set



1954 All except Skylark.
TLG54S.....(Set of 4).....\$9.75 set



1955 Tail lamp lens gasket.
TLG55.....\$9.50 pr.

1956 Tail lamp lens gasket.
TLG56.....\$9.50 pr.

1957 Special and Century.
TLG57.....\$9.50 pr.

1957 Super and Roadmaster.
TLG57B.....\$9.00 pr.

1957 All. (for oval stop lamp lens).
SLG57.....\$7.25 pr.

1958 all Special and Century.
TLG58S.....\$31.25 pr.

1958 Super and Roadmaster.
TLG58B.....\$31.25 pr.

1960 All.
TLG60.....\$31.25 pr.



Tail Lamp Mounting Pads (2.660)

-  **1933-1935 All Series.**
TLP335\$43.25 pr.
-  **1936 All Series.**
TLP36\$32.50 pr.
-  **1937 Special and Century.**
TLP37\$33.25 pr.
- 1937 Series 80 and 90.**
TLP37B\$66.50 pr.
-  **1938 Special and Century.**
TLP38\$34.50 pr.
- 1938-1940 Series 80 and 90.**
TLP380\$54.25 pr.
-  **1939-1940 Special and Century.**
TLP390\$22.50 pr.
-  **1939-1940 Super and Roadmaster.**
TLP40\$42.50 pr.
-  **1941 Four door touring Sedan and four door convertible. Phaeton. Models 51, 51C, 71, 71C.**
TLP41A\$76.50 pr.
- 1941 Series 50, 70 coupes and convertible coupes. Models 56, 56C, 56S, 76C, 76S.**
TLP41B\$76.00 pr.
- 1941-1942 Series 90 only.**
TLP41C\$93.75 pr.
-  **1937-1959 Horn Contact Wire**
1937-1959 All.
HCW379\$21.75 ea.

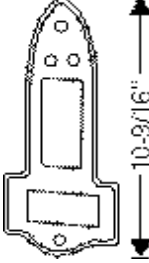
-  **1941-1949**
1941-1942: Model 41, 41 SE, 61;
1946-1949: Model 41.
TLP41D\$76.50 pr.
- 1941-1949**
1941-1942: Series 40 and 60 coupes;
1946-1949: Model 46S.
TLP41E\$76.50 pr.

-  **1942-1948 Super and Roadmaster.**
TLP428\$49.50 pr.

- 1950-1952**
1950: All Series;
1951-1952: Super and Roadmaster.
TLP502\$8.50 pr.

-  **1951-1952 Specials.**
TLP512\$23.50 pr.

-  **1953 All. Seal, tail lamp bodies to fender. Four required per car. Four in set. (2.685)**
TLP53\$107.50 set

-  **1954 All. Tail lamp rubber mounting pad. Four required per car. (Except Skylark)**
TLP54\$88.50 set

-  **1954 Skylark. Seal, tail lamp to fender. (8.204)**
TLP54S\$91.00 pr.

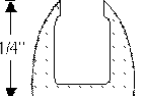
-  **1955-1957 All.**
TLP557\$21.00 pr.

Signal Flashers

-  **1941-1953 All. Six volt directional signal flasher.**
SF413\$12.75 ea.
- 1953-1960 All 12 volt.**
SF530\$10.75 ea.

Directional Signal Return Spring

-  **1955-1960 All.**
CS550\$12.75 ea.

Tail Lamp Parts (Group 2)



1949 Gasket junction block for taillight wiring. One pair per car. Series 50 & 70.
TWG49.....\$6.00 pr.

1950-1951 Boot and hose, tail lamp wiring. Four piece set includes end covers.

1950: all models;
1951: Series 50 and 70.

TWB501.....\$126.75 set

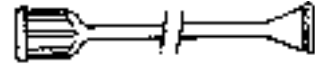

1953 Boot, tail lamp and turn signal wiring. Excellent quality tubing with correct molded ends. Order two pair per car.

TWB53.....(All except Skylark).....\$74.00 pr.
TWB53X.....(Skylark - 4 piece set).....\$262.25 set

1954 All except Skylark.
Seal, reflector signal, between taillights. A smaller replacement for 1953.

RS534.....\$18.50 pr.

1942-1948 Tail Lamp Bezels

Die cast chrome. Fits either side.



1942-1948 Super & Roadmaster
These parts are sold as "seconds". They may have small pitting or imperfections in the chrome. Great for the "driver".

For Super and Roadmaster series.

TB428BS.....\$29.75 ea.

1950-1952 Tail Lamp Bezel



Die cast chrome. Fits either side.
Beautiful reproduction.

1950: All;
1951-1952: Super and Roadmaster.

TB502.....\$41.00 ea.

Screws for Above.

LDS502.....\$3.25 ea.



NOTICE CAR SHOW ATTENDEES FREE DELIVERIES

We will be happy to bring any parts you need.
Please call in advance of the show to place your order.

Look For Us!

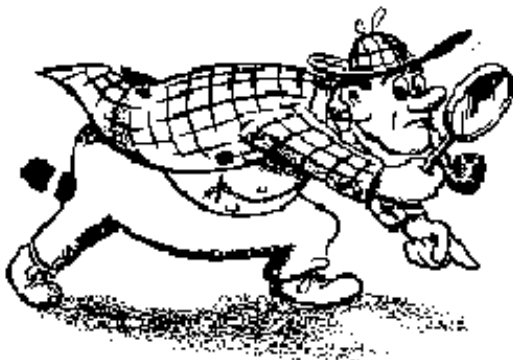

If your thinking of attending any of the shows listed below, be sure to stop by and say "Hello". We will be glad to discuss some of our newest items or simply talk about your **BUICK**.

Plan ahead by calling-in your order weeks ahead of time. We will be able to bring your entire order and save you shipping too.

*GS Nationals
Buick Nationals
Hershey

GDB 31-34

Back-up Lenses (2.697)



1950-1953 "Guide".
1950: All;
1951-1953: Super, Roadmaster, Skylark.
 BL503\$19.50 ea.



1951-1953 Special.
 BL513\$18.50 ea.

1954 All except Skylark. "Guide"
 BL54\$26.50 ea.



1955 All. "Guide"
 BL55\$22.50 ea.
 S26.....Correct Stainless Screws....\$1.15 ea.



1956 All. "Guide".
 BL56\$32.50 ea.



1957 all. "Guide".
 BL57\$39.50 ea.

Back-up Lens Gaskets



1949 All Super and Roadmaster. Gaskets.
 BLG49\$5.25 pr.



1950-1953
1950 all:
1951-1953: Super, Roadmaster, Skylark.
 BLG503\$5.00 pr.



1951-1953 All Specials.
 BLG513\$4.50 pr.



1955 Back-up lamp lens gaskets.
 BLG55\$6.00 pr.



1956 Back-up lamp lens gaskets.
 BLG56\$6.50 pr.



1957 All.
 BLG57\$7.25 pr.

Back-up Lamp Parts



1949 Gasket, back up light housing.
 One pair per car. All Super and Roadmasters (except station wagons).
 BLP49\$29.75 pr.

1949 Series 50 and 70. Seal, backup lamp housing to inside of body. One pair per car.
 BLS49.....\$5.25 pr.



1950-1963 Back-up lamp door chrome plated steel.
1950: All;
1951-1953: Super, Roadmaster and Skylark.
 LD503\$19.50 ea.



Screws for the above. Correct highly polished stainless steel.
 LDS503.....\$2.95 ea.



1951-1953 Special deluxe back-up light chrome ring.
 BR513\$29.50 ea.

License Lenses



1954-1955 All
 LL545L.....LH Side.....\$17.50 ea.
 LL545R.....RH Side.....\$17.50 ea.
 LLG545.....(Gaskets).....\$6.50 pr.



1956 License Lamp Lens
 LL56\$21.50 ea.
 LLG56.....(Gasket).....\$3.50 ea.

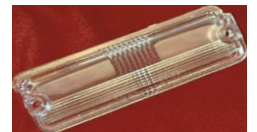

1959 License Lamp Lens
 LL59\$51.00 ea.



Fog Lamp Kit

All years as required. Two 5 " 12 volt amber lamps in chrome housings. Easy mounting stud with wire.
 FL300\$62.50 pr.

Bulbs and Fuses (Group 2)



Bulbs (8.991)



Year & Model	Head-light	Parking	Direction Front	Signal Rear	Tail	Stop	License Plate	Instru-ment	Indicator	Dome	Back-up
'35-'36	B2330/B2331	B55	----	----	B63	B87	B63	B55	B51	B81	----
'37, '38, '39	B2330/B2331	B55	-----	-----	B1154	B1154	B63	B55	B51	B81	----
'40	SB6	B1154	B1154	-----	B1154	B1154	B63	B55	B51	B81	-----
'41	SB6	B1154	B1154	-----	B1154	B1154	B63	B55	B51	B82	-----
'42	SB6	B1154	B1154	B1129	B1154	B1154	B63	B55	B51	B88	-----
'46-'49 (series 40)	SB6	B1154	B1154	B1129	B1154	B1154	B63	B55	B51	B81	B82
'46-'48 (ser. 50, 70)	SB6	B1154	B1154	B1154	B1154	B1154	B63	B55	B51	B81	B82
'49 (series 50 & 70)	SB6	B1154	B1154	B1154	B1154	B1154	B63	B55	B51	B88	B1129
'50	SB6	B1154	B1154	B1129	B1154	B1154	B63	B55	B51	B88	B1129
'51-'52	SB6	B63 B1154	B1154	B1129	B1154	B1154	B63	B55	----	B88	B1129 B1133
'53 (series 40)	SB6	B1154	B1154	B1129	B1154	B1154	B63	B55	B51	B210	B1133
'53 (ser. 50-70 12V)	SB12	B1034	B1034	B1073	B1034	B1034	B67	B57	B53	B1004	B1073
'54	SB12	B1034	B1034	B1073	B1034	B1034	B67	B57	B53	B90 B1004	B1073
'55	SB12	B1034	B1034	B1034	B1034	B1034	B67	B57	B53	B90 B1004	B1073
'56	SB12	B1034	B1034	B1034	B1034	B1034	B67	B57	B57	B90 B1004	B1073
'57	SB12	B1034	B1034	B1073	B67	B1073	B67	B57	B53	B90 B1004	B1073
'58	SB1, SB2	B1034	B1034	B1034	B1034	B1034	B67	B57	B57	B90 B1004	B1073
59	SB1, SB2	B1034	B1034	B1034	B1034	B1034	B67	B57	B57	B90 B1004	B1073
'60	SB1, SB2	B1034	B1034	B1034	B1034	B1034	B67	B5357	B57	B90 B1004	B1073

Prices: **B51**-\$1.50, **B53**-\$1.50, **B55**-\$1.50, **B57**-\$1.25, **B63**-\$1.25, **B67**-\$1.50, **B81**-\$1.75, **B82**-\$1.50, **B87**-\$2.00, **B88**-\$2.50, **B89**-\$2.00, **B90**-\$2., **B210**-\$5.25, **B1000**-\$5.75, **B1004**-\$2.75, **B1034**-\$2.75, **B1073**-\$2.75, **B1129**-\$2.75, **B1133**-\$4.00, **B1154**-\$2.00, **B1157**-\$2.00, **B2330**-\$8.75, **B2331** (High Intensity Bulb)-\$16.50, **SB1**-\$11.25, **SB2**-\$11.25, **SB6**-\$12.50, **SB12**-\$12.25.



www.oldbuickparts.com

908-369-3666

Headlamp Sockets



For 3 prong beam numbers SB6, 6006, SB12, 6012, SB2, 4000 and 4002.
PT6\$4.75 ea.



For 2 prong beam numbers SB1, 4001.
PT7\$4.25 ea.

Lamp Sockets and Pigtails



Single contact with lead. Fits bulb numbers 51, 53, 55 and 57.
PT1\$2.25 ea.

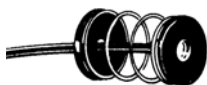

Single contact with lead. Fits bulb numbers 63, 67, 81, 87, 89, 1073, 1129, 1133, 1141 and 1156.
PT2\$2.25 ea.

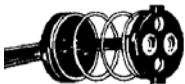

Double contact with lead. For ears reversed. Bulbs numbers 82, 88, 90, 210, 1004, 1034, 1154 and 1157.
PT3\$2.75 ea.



Double contact with lead. For ears aligned bulbs.
PT4\$2.50 ea.

Parking and Tail Lamp Sockets

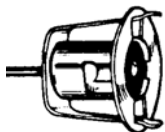

Single contact with lead. For 3/4" to 1 1/8" hole.
LS1\$4.25 ea.

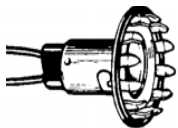

Double contact with lead. For bulb numbers 1034 and 1154. Fits 1 1/8" hole.
LS5\$5.75 ea.

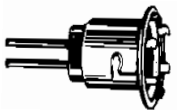

Double contact with leads. Fits 3/4" hole. For bulb numbers 1034, 1154 and 1157.
LS9\$5.75 ea.



Double contact with leads. Fits 3/4" to 1 1/8" hole. For bulb numbers 1034, 1154 and 1157.
LS2\$5.75 ea.



Double contact with leads. Fits 3/4" to 1 1/8" hole. For bulb numbers 82, 88, 90, 210 and 1004.
LS3\$7.90 ea.



Double contact with leads. Fits 1 1/8" hole. For bulb numbers 1034, 1154 and 1157.
LS4\$5.75 ea.

Interior/Dash Sockets



Single contact with lead for dome etc. For bulb numbers 63, 67, 81 89, 1073, 1129 and 1133.
PT8\$8.75 ea.



Double contact with lead. For dome and map lamps. Reversed ears. Bulb numbers 82, 88, 90, 210 and 1004.
PT9\$7.00 ea.



Double contact with lead for ears aligned bulbs.
PT10\$2.50 ea.

Back-Up and License Lamp Sockets

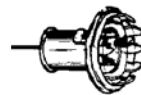

Single contact with lead. Fits 3/4" hole. Bulb numbers 63, 67, 81, 89 1129 and 1133.
LS6\$5.75 ea.



Single contact with lead. Fits 1 1/8" hole with ground wire. For bulb numbers 63, 67, 81, 89, 1129 and 1133.
LS7TOS



Single contact with lead. Fits 1 1/8" hole. For bulb numbers 63, 67, 81, 89, 1129 and 1133.
LS8\$6.00 ea.

Wiring Harnesses (Group 2)

Each harness is manufactured with factory color code specifications and made from patterns developed from original Buick harnesses. Each wire is tagged or identified individually for easy installation. We offer the largest selection of Buick harnesses found anywhere. Don't see your particular harness listed here? We can develop a new harness from your old one. Please call for more information.

[Early] 1936 BUICK Special / Series 40

[Headlight Switch had 8 Terminals]

WH3640EM.....	Main Lighting Harness.....	\$764.40
WH3640EHG.....	Horn Button Ground Wire	\$6.60
WH3640EDE.....	Dash and Engine Harness	\$262.80
WH3640EI.....	Instrument Light Wiring	\$8.80
WH3640ECL.....	Cigar Lighter Wire	\$4.40
WH3640EC.....	Clock Harness	\$56.40
WH3640EFT.....	Fuel Tank Connector Wire	\$5.50
WH3640EGS.....	Engine Ground Strap	\$37.20

[Late] 1936 BUICK Special / Series 40

[Headlight Switch had 10 Terminals]

WH3640LHB.....	Headlight Bucket Wires [pair]	\$49.20
WH3640LFL.....	Fender Light Bucket Wires [pair]	\$42.35
WH3640LM.....	Main Lighting Harness	\$758.40
WH3640LHG.....	Horn Button Ground Wire	\$6.60
WH3640LDE.....	Dash and Engine Harness	\$262.80
WH3640LI.....	Instrument Light Wiring	\$9.90
WH3640LCL.....	Cigar Lighter Wire	\$5.50
WH3640LC.....	Clock Harness	\$56.40
WH3640LFT.....	Fuel Tank Connector Wire	\$5.50
WH3640LGS.....	Engine Ground Strap	\$37.20

[Late] 1936 BUICK Century / Series 60

[Headlight Switch had 10 Terminals]

WH3660LHB.....	Headlight Bucket Wires [pair]	\$49.20
WH3660LFL.....	Fender Light Bucket Wires [pair]	\$42.35
WH3660LM.....	Main Lighting Harness	\$728.40
WH3660LHG.....	Horn Button Ground Wire	\$6.60
WH3660LDE.....	Dash and Engine Harness	\$265.20
WH3660LI.....	Instrument Light Wiring	\$9.90
WH3660LCL.....	Cigar Lighter Wire	\$5.50
WH3660LC.....	Clock Harness	\$56.40
WH3660LDL4.....	Dome Light Wiring [4dr.sedan]	\$13.20
WH3660LDL2.....	Dome Light Wiring [2dr.sedan]	\$13.20
WH3660LFT.....	Fuel Tank Connector Wire	\$5.50

[Early] 1936 BUICK Roadmaster / Series 80

WH3680M.....	Main Lighting Harness	\$798.00
WH3680DE.....	Dash and Engine Harness	\$266.40

Wiring Harness Tape

Non-adhesive vinyl Harness wrap is same as used by GM.
1" wide, 100 foot roll.

WT100.....	1" wide.	\$11.25 roll
------------	---------------	--------------

1937 BUICK Special / Series 40

WH3740DEH.....	Dash, Engine and Headlight Harness ..	\$796.80
WH3740I.....	Instrument Light Wiring	\$34.10
WH3740C.....	Clock and Glove Box Harness	\$75.60
WH3740BT.....	Body and Taillights Harness [2dr.coupe] ..	\$325.20
WH3740BT4.....	Body and Taillights Harness [4dr.sedan] ..	\$331.20
WH3740DLS.....	Dome Light Wiring [4dr.sedan]	\$16.50
WH3740FT.....	Fuel Tank Connector Wire	\$12.50
WH3740GS.....	Engine Ground Strap	\$39.50

1937 BUICK Century / Series 60

WH3760DEH.....	Dash, Engine and Headlight Harness ...	\$723.60
WH3760I.....	Instrument Light Wiring	\$35.20
WH3760C.....	Clock and Glove Box Harness	\$75.60
WH3760FT.....	Fuel Tank Connector Wire	\$9.90
WH3760GS.....	Engine Ground Strap	\$37.20

1937 BUICK Roadmaster / Series 80

WH3780DEH.....	Dash, Engine and Headlight Harness	\$744.00
WH3780I.....	Instrument Light Wiring	\$35.20
WH3780BT4.....	Body and Taillights Harness [4dr.sedan] ..	\$358.80
WH3780FT.....	Fuel Tank Connector Wire	\$9.90
WH3780GS.....	Engine Ground Strap	\$37.20

1937 BUICK Limited / Series 90

WH3790DEH.....	Dash, Engine and Headlight Harness ...	\$744.00
WH3790I.....	Instrument Light Wiring	\$35.20
WH3790BT.....	Body and Taillights Harness	\$235.20
WH3790IL.....	Interior Light and Door Switch Wiring	\$145.20
WH3790FT.....	Fuel Tank Connector Wire	\$9.90
WH3790GS.....	Engine Ground Strap	\$37.20

1938 BUICK Special / Series 40

WH3840DEH.....	Dash, Engine and Headlight Harness ...	\$854.40
WH3840BT.....	Body and Taillights Harness [2dr.coupe] ..	\$364.80
WH3840BT4.....	Body and Taillights Harness [4dr.sedan] ..	\$376.80
WH3840BTC.....	Body and Taillights Harness [2dr.conv.] ..	\$346.80
WH3840FL.....	Fender Light Bucket Wires [pair]	\$42.00
WH3840C.....	Clock and Glove Box Harness	\$75.60
WH3840HB.....	Headlight Bucket Wires [pair]	\$43.20
WH3840FT.....	Fuel Tank Connector Wire	\$11.00
WH3840HS.....	Heater Switch Wiring	\$31.90
WH3840TB.....	Taillight Bucket Wires [pair]	\$56.40

1938 BUICK Century / Series 60

WH3860HB.....	Headlight Bucket Wires [pair]	\$43.20
WH3860FL.....	Fender Light Bucket Wires [pair]	\$42.00
WH3860DEH....	Dash, Engine and Headlight Harn. [lhd]..	\$854.40
WH3860DEHR..	Dash, Engine and Headlight Harn. [rhd]..	\$874.80
WH3860C.....	Clock and Glove Box Harness	\$75.60
WH3860HS.....	Heater Switch Wiring	\$31.90
WH3860BT4.....	Body and Taillights Harness [4dr.sedan] ..	\$376.80
WH3860FT.....	Fuel Tank Connector Wire	\$12.10
WH3860TB.....	Taillight Bucket Wires [pair]	\$56.40

1938 BUICK Roadmaster / Series 80

WH3880HB.....	Headlight Bucket Wires [pair]\$43.20
WH3880FL.....	Fender Light Bucket Wires [pair]\$42.00
WH3880DEH.....	Dash, Engine and Headlight Harness	..\$926.40
WH3880BTL.....	Body Harness\$502.74
WH3880HS.....	Heater Switch Wiring\$31.90
WH3880C.....	Clock and Glove Box Harness\$75.60
WH3880TB.....	Taillight Bucket Wires [pair]\$56.40
WH3880FT.....	Fuel Tank Connector Wire\$12.10

1938 BUICK Limited / Series 90

WH3890HB.....	Headlight Bucket Wires [pair]\$43.20
WH3890FL.....	Fender Light Bucket Wires [pair]\$42.00
WH3890DEH.....	Dash, Engine and Headlight Harness	..\$926.40
WH3890BTL.....	Body and Taillights Harness [4dr.limo]	..\$580.80
WH3890C.....	Clock and Glove Box Harness\$75.60
WH3890HS.....	Heater Switch Wiring\$31.90
WH3890TB.....	Taillight Bucket Wires [pair]\$56.40
WH3890FT.....	Fuel Tank Connector Wire\$12.10

1939 BUICK Special / Series 40

WH3940HB.....	Headlight Bucket Wires [pair]\$86.40
WH3940FL.....	Park and Turn Signal Bucket Wires [pair]\$86.30
WH3940DEH.....	Dash, Engine and Headlight Harness\$723.60
WH3940BT2....	Body and Taillights Harness [2dr.coupe]	\$428.40
WH3940BT4S...	Body and Taillights Harness [4dr.sedan]	\$435.60
WH3940BTH...	Body and Taillights Harness [hearse]\$458.40
WH3940TS.....	Turn Signal Switch Harness\$114.00
WH3940C.....	Clock and Glove Box Harness\$78.00
WH3940FT.....	Fuel Tank Connector Wire\$12.10

1939 BUICK Century / Series 60

WH3960HB.....	Headlight Bucket Wires [pair]\$86.40
WH3960FL.....	Park and Turn Signal Bucket Wires [pair]\$69.30
WH3960TS.....	Turn Signal Switch Harness\$114.00
WH3960FT.....	Fuel Tank Connector Wire\$12.10
WH3960DEH.....	Dash, Engine and Headlight Harness\$817.20
WH3960C.....	Clock and Glove Box Harness\$78.00
WH3960BT2C..	Body and Taillights Harness [2dr.conv.]	..\$435.60
WH3960BT2P..	Body and Taillights Harness [2dr.coupe]	..\$428.40
WH3960BTS...	Body and Taillights Harness [4dr.sedan]	..\$435.60
WH3960LL.....	License Light Wires\$8.80

1939 BUICK Roadmaster / Series 80

WH3980HB.....	Headlight Bucket Wires [pair]\$86.40
WH3980FL.....	Park and Turn Signal Bucket Wires [pair]\$69.30
WH3980DEH....	Dash, Engine and Headlight Harness\$842.40
WH3980TS.....	Turn Signal Switch Harness\$112.10
WH3980C.....	Clock and Glove Box Harness\$80.60
WH3980BT.....	Body/Taillights Harness w/o turns\$502.40
WH3980BTS.....	Body/Taillights Harness w/ turns\$599.40
WH3980FT.....	Fuel Tank Connector Wire\$12.10

1939 BUICK Limited / Series 90

WH3990HB.....	Headlight Bucket Wires [pair]\$86.40
WH3990FL.....	Park and Turn Signal Bucket Wires [pair]\$69.30
WH3990DEH.....	Dash, Engine and Headlight Harness\$842.40
WH3990TS.....	Turn Signal Switch Harness\$112.10
WH3990C.....	Clock and Glove Box Harness\$80.60
WH3990BT.....	Body/Taillights Harness w/o turns\$488.85
WH3990BTS.....	Body/Taillights Harness w/ turns\$530.45
WH3990FT.....	Fuel Tank Connector Wire\$12.10

1940 BUICK Special / Series 40

WH4040HB.....	Headlight Bucket Wires [pair]\$79.20
WH4040FL.....	Park and Turn Signal Bucket Wires [pair]\$70.80
WH4040DEH.....	Dash, Engine and Headlight Harness\$907.20
WH4040BT.....	Body and Taillights Harness [2dr.coupe]	\$428.40
WH4040BT4....	Body and Taillights Harness [4dr.sedan]	\$435.60
WH4040TS.....	Turn Signal Switch Harness\$88.80
WH4040C.....	Clock and Glove Box Harness\$79.20
WH4040I.....	Instrument Light Cluster\$61.20
WH4040CL.....	Cigar Lighter Feed Wire\$12.10
WH4040FT.....	Fuel Tank Connector Wire\$12.10
WH4040LL.....	License Light Wires\$9.90

1940 BUICK Super / Series 50

WH4050HB.....	Headlight Bucket Wires [pair]\$79.20
WH4050FL.....	Park and Turn Signal Bucket Wires [pair]\$70.80
WH4050DEH.....	Dash, Engine and Headlight Harness\$870.00
WH4050I.....	Instrument Light Cluster\$61.20
WH4040IA.....	Instrument Light Cluster w/ Ashtray Lite\$68.40
WH4050TS.....	Turn Signal Switch Harness\$88.80
WH4050C.....	Clock and Glove Box Harness\$79.20
WH4050HD.....	Heater and Defroster Wiring\$37.20
WH4050CL.....	Cigar Lighter Feed Wire\$12.10
WH4050BTC.....	Body and Taillights Harness [conv.]\$435.60
WH4050BT.....	Body and Taillights Harness [2dr.coupe]	\$428.40
WH4050BT4....	Body and Taillights Harness [4dr.sedan]	\$435.60
WH4050FT.....	Fuel Tank Connector Wire\$12.10
WH4050LL.....	License Light Wires\$9.90

1940 BUICK Century / Series 60

WH4060HB.....	Headlight Bucket Wires [pair]\$79.20
WH4060FL.....	Park and Turn Signal Bucket Wires [pair]\$70.80
WH4060DEH.....	Dash, Engine and Headlight Harness\$896.40
WH4060TS.....	Turn Signal Switch Harness\$88.80
WH4060C.....	Clock and Glove Box Harness\$79.20
WH4060I.....	Instrument Light Cluster\$61.20
WH4060CL.....	Cigar Lighter Feed Wire\$12.10
WH4060BT4...	Body and Taillights Harness [4dr.sedan]	..\$463.20
WH4060FT.....	Fuel Tank Connector Wire\$12.10
WH4060LL.....	License Light Wires\$9.90

Wiring Harnesses (Group 2)

1940 BUICK Roadmaster / Series 70

WH4070HB.....	Headlight Bucket Wires [pair]\$79.20
WH4070FL.....	Park and Turn Signal Bucket Wires [pair]	..\$70.80
WH4070DEH....	Dash, Engine and Headlight Harness\$870.00
WH4070BT4...	Body and Taillights Harn. [4dr.sedan]\$394.40
WH4070TS.....	Turn Signal Switch Harness\$88.80
WH4070C.....	Clock and Glove Box Harness\$79.20
WH4070CL.....	Cigar Lighter Feed Wire\$11.00
WH4070I.....	Instrument Light Cluster\$68.40
WH4070TB.....	Taillight Bucket Wires [pair]\$58.10
WH4070FT.....	Fuel Tank Connector Wire\$11.00
WH4070LL.....	License Light Wires\$7.70

1940 BUICK Limited / Series 80

WH4080HB.....	Headlight Bucket Wires [pair]\$79.20
WH4080FL.....	Park and Turn Signal Bucket Wires [pair]	..\$70.80
WH4080DEH....	Dash, Engine and Headlight Harness	..\$949.20
WH4080BT4	Body and Taillights Harn. [4dr.sedan/4819]	\$435.60
WH4080TS.....	Turn Signal Switch Harness\$88.80
WH4080C.....	Clock and Glove Box Harness\$79.20
WH4080I.....	Instrument Light Cluster\$61.20
WH4080TB.....	Taillight Bucket Wires [pair]\$56.40
WH4080CL.....	Cigar Lighter Feed Wire\$11.00
WH4080FT.....	Fuel Tank Connector Wire\$11.00
WH4080LL.....	License Light Wires\$7.70

1940 BUICK Limited / Series 90

WH4090HB.....	Headlight Bucket Wires [pair]\$79.20
WH4090FL.....	Park and Turn Signal Bucket Wires [pair]\$70.80
WH4090DEH....	Dash, Engine and Headlight Harness\$949.20
WH4090BT4..	Body & Taillights Harn. [4dr.sedan/4923]\$574.80
WH4090TS.....	Turn Signal Switch Harness\$88.80
WH4090C.....	Clock and Glove Box Harness\$79.20
WH4090I.....	Instrument Light Cluster\$61.20
WH4090TB.....	Taillight Bucket Wires [pair]\$56.40
WH4090CL.....	Cigar Lighter Feed Wire\$11.00
WH4090FT.....	Fuel Tank Connector Wire\$11.00
WH4090LL.....	License Light Wires\$7.70

1941 BUICK Special / Series 40

WH4140HB.....	Headlight Bucket Wires [pair]\$98.40
WH4140FL.....	Park and Turn Signal Bucket Wires [pair]	...\$88.80
WH4140DEH.	Dash, Eng. and Headlight Harness [41SE].	\$968.40
WH4140DEHS.	Dash, Eng. & Headlight Harn. [ex.41SE].	\$968.40
WH4140C.....	Clock Harness\$97.20
WH4140I.....	Instrument Light Cluster\$61.20
WH4140HD.....	Heater and Defroster Wiring\$52.80
WH4140BT..	Body and Taillights Harness [2dr.sedanet]	..\$567.60
WH4140BTC...	Body and Taillights Harness [2dr.conv.]	..\$547.20
WH4140FT.....	Fuel Tank Connector Wire\$11.00
WH4140LL.....	License Light Bucket Wire\$7.70

1941 BUICK Super / Series 50

WH4150HB.....	Headlight Bucket Wires [pair]\$98.40
WH4150FL.....	Park and Turn Signal Bucket Wires [pair]	...\$88.80
WH4150DEH....	Dash, Eng. and Headlight Harness\$968.40
WH4150I.....	Instrument Light Cluster\$61.20
WH4150HD.....	Heater and Defroster Wiring\$52.80
WH4150BTC...	Body and Taillights Harness [2dr.conv.]	..\$547.20
WH4150BT...	Body and Taillights Harness [4dr.sedan]	...\$600.00
WH4150FT.....	Fuel Tank Connector Wire\$11.00
WH4150LL.....	License Light Bucket Wire\$7.70

1941 BUICK Century / Series 60

WH4160HB.....	Headlight Bucket Wires [pair]\$98.40
WH4160FL.....	Park and Turn Signal Bucket Wires [pair]	...\$88.80
WH4160DEH....	Dash, Eng. and Headlight Harness\$955.20
WH4160I.....	Instrument Light Cluster\$61.20
WH4160HD.....	Heater and Defroster Wiring\$52.80
WH4160BT...	Body and Taillights Harness [4dr.sedan]	...\$490.15
WH4160BTC...	Body and Taillights Harness [2dr.conv.]	..\$547.20
WH4160FT.....	Fuel Tank Connector Wire\$11.00
WH4160LL.....	License Light Bucket Wire\$7.70

1941 BUICK Roadmaster / Series 70

WH4170HB.....	Headlight Bucket Wires [pair]\$98.40
WH4170FL.....	Park and Turn Signal Bucket Wires [pair]	...\$88.80
WH4170DEH....	Dash, Eng. and Headlight Harness\$955.20
WH4170I.....	Instrument Light Cluster\$61.20
WH4170HD.....	Heater and Defroster Wiring\$52.80
WH4170BTC...	Body and Taillights Harness [2dr.conv.]	..\$547.20
WH4170BT...	Body and Taillights Harness [4dr.sedan]	...\$600.00
WH4170BTP..	Body and Taillights Harness [4dr.phaeton]	..\$786.00
WH4170FT.....	Fuel Tank Connector Wire\$11.00
WH4170LL.....	License Light Bucket Wire\$7.70

1941 BUICK Limited / Series 90

WH4190HB.....	Headlight Bucket Wires [pair]\$98.40
WH4190FL.....	Park and Turn Signal Bucket Wires [pair]	...\$88.80
WH4190DEH....	Dash, Eng. and Headlight Harness\$955.20
WH4190I.....	Instrument Light Cluster\$61.20
WH4190HD.....	Heater and Defroster Wiring\$52.80
WH4190FT.....	Fuel Tank Connector Wire\$11.00

1942 BUICK Roadmaster / Series 70

WH4270HB.....	Headlight Bucket Wires [pair]\$98.40
WH4270FL.....	Park and Turn Signal Bucket Wires [pair]	...\$86.40
WH4270DEH.....	Dash, Eng. and Headlight Harness\$794.40
WH4270I.....	Instrument Light Cluster\$61.20
WH4270C.....	Clock Harness\$97.20
WH4270GB.....	Glove box Harness\$7.90
WH4270HD.....	Heater and Defroster Wiring\$30.00
WH4270PT.....	Power Top Control Harness\$400.80
WH4270BT..	Body and Taillights Harness [2dr.sedanet]	..\$474.00
WH4270BTC...	Body and Taillights Harness [2dr.conv.]	..\$705.60
WH4270FT.....	Fuel Tank Connector Wire\$11.00

1947 BUICK Super / Series 50

WH4750HB.....	Headlight Bucket Wires [pair]\$100.88
WH4750DEH.....	Dash, Eng. and Headlight Harness\$889.20
WH4750I.....	Instrument Light Cluster\$61.20
WH4750FT.....	Fuel Tank Connector Wire\$11.00

1948 BUICK Special / Series 40

WH4840HB.....	Headlight Bucket Wires [pair]\$100.80
WH4840FL.....	Park and Turn Signal Bucket Wires [pair]	...\$86.40
WH4840DEH.....	Dash, Eng. and Headlight Harness\$1005.60
WH4840C.....	Clock Harness\$97.20
WH4840I.....	Instrument Light Cluster\$61.20
WH4840BT..	Body and Taillights Harness [2dr.sedanet]	..\$599.20
WH4840FT.....	Fuel Tank Connector Wire\$11.00

1948 BUICK Super / Series 50

WH4850HB.....	Headlight Bucket Wires [pair]\$100.88
WH4850FL.....	Park and Turn Signal Bucket Wires [pair]	...\$86.40
WH4850DEH.....	Dash, Eng. and Headlight Harness\$1009.20
WH4850I.....	Instrument Light Cluster\$61.20
WH4850BT..	Body and Taillights Harness [2dr.sedan]\$483.85
WH4850FT.....	Fuel Tank Connector Wire\$11.00
WH4850HD.....	Heater and Defroster Wiring\$30.00
WH4850TS.....	Turn Signal Switch Harness\$103.20
WH4850BTS...	Body and Taillights Harness [4dr.sedan]	..\$885.60
WH4850BTC.....	Body and Taillights Harness [conv.]\$723.60
WH4850PT....	Power Window & Top Control Harness\$385.55
WH4850PS.....	Power Seat Control Harness (conv.)\$92.40
WH4850FT.....	Fuel Tank Connector Wire\$11.00
WH4850LL.....	License Light Bucket Wire\$12.10

1948 BUICK Roadmaster / Series 70

WH4870HB.....	Headlight Bucket Wires [pair]\$100.80
WH4870FL.....	Park and Turn Signal Bucket Wires [pair]	...\$86.40
WH4870DEHS.	Dash, Eng. & Headlight Harn.(std.trans)	.\$1009.40
WH4870DEH.	Dash, Eng. & Headlight Harn.(auto.trans)	.\$1021.20
WH4870I.....	Instrument Light Cluster\$61.20
WH4870C.....	Clock Harness\$102.00
WH4870BT.....	Body and Taillights Harness [conv.]\$723.20
WH4870PT..	Power Window & Top Control Harn. (conv)	\$434.40
WH4870PS.....	Power Seat Control Harness (conv.)\$92.40
WH4870FT.....	Fuel Tank Connector Wire\$11.00
WH4870BL.....	Back-up Light Bucket Wires\$42.00

1949 BUICK Super / Series 50

WH4950HB.....	Headlight Bucket Wires [pair]\$82.50
WH4950FL.....	Park and Turn Signal Bucket Wires [pair]\$78.00
WH4950SH.....	Starter to Ignition Harness. (auto trans)\$204.00
WH4950SHS....	Starter to Ignition Harness. (std. trans)\$204.00
WH4950HR.....	Horn Realy to Horn Wiring.....	\$12.10
WH4950DEH.	Dash, Eng. & Headlight Harn. (auto trans)	..\$867.60
WH4950DEHS.	Dash, Eng. & Headlight Harn. (std. trans)	\$867.60
WH4950TS.....	Turn Signal Switch Harness\$103.20
WH4950BTC.....	Body and Taillights Harness [conv.]\$594.00
WH4950BTS..	Body and Taillights Harness [4dr.sedan]	..\$642.00
WH4950BTW....	Body and Taillights Harness [wagon]\$670.80
WH4950FT.....	Fuel Tank Connector Wire\$8.80
WH4950LL.....	License Light Bucket Wire\$12.10

1949 BUICK Roadmaster / Series 70

WH4970HB.....	Headlight Bucket Wires [pair]\$82.80
WH4970FL.....	Park and Turn Signal Bucket Wires [pair]\$78.00
WH4970SH.....	Starter to Ignition Harness. (auto trans)\$204.00
WH4970HR.....	Horn Realy to Horn Wiring.....	\$11.00
WH4970TS.....	Turn Signal Switch Harness\$103.20
WH4970DEH.	Dash, Eng. & Headlight Harn. (auto trans)	..\$867.60
WH4970DEHS.	Dash, Eng. & Headlight Harn. (std. trans)	\$867.60
WH4970BTC.....	Body and Taillights Harness [conv.]\$556.90
WH4970BTR.....	Body and Taillights Harn. [2-dr. ht]\$742.80
WH4970BTS..	Body and Taillights Harness [4dr.sedan]	..\$651.40
WH4970BTA....	Body and Taillights Harness [ambul]\$506.40
WH4970PT....	Power Window & Top Control Harness\$676.60
WH4970PS... Power Seat Control Harness (4-dr sedan)	...\$92.40	
WH4970FT.....	Fuel Tank Connector Wire\$8.80
WH4970LL.....	License Light Bucket Wire\$12.10

1950 BUICK Special / Series 40

(Early Models, heater & blower switches are side by side)

WH5040HB.....	Headlight Bucket Wires [pair]\$82.80
WH5040FL.....	Park and Turn Signal Bucket Wires [pair]\$73.20
WH5040DEH.	Dash, Eng. & Headlight Harn.(auto trans)	.\$1033.20
WH5040DEHS.	Dash, Eng. & Headlight Harn.(std. trans)	\$1033.50
WH5040TS.....	Turn Signal Switch Harness. (pair)\$108.00
WH5040GB.....	Glove box Light Switch Wire\$6.60
WH5040ML.....	Map Light Wiring\$13.20
WH5040BT.....	Body and Taillights Harness\$304.80

Note: Tail Lamp Wiring requires the purchase of our TWB501

WH5040IL..	Interior light & Door Switch 43,43D,46,46S\$520.80
WH5040FT.....	Fuel Tank Connector Wire\$7.70
WH5040BL.....	Back-up Light Bucket Wires\$39.60
WH5040LL.....	License Light Bucket Wire\$39.60

Wiring Harnesses (Group 2)

1950 BUICK Special / Series 40

(Late Models, heater & blower switches are separated)

WH5040LHB.....	Headlight Bucket Wires [pair]\$82.80
WH5040LFL....	Park and Turn Signal Bucket Wires [pair]	...\$73.20
WH5040LDH..	Dash, Eng. & Headlight Harn.(auto trans)	.\$1044.00
WH5040LDHS.	Dash, Eng. & Headlight Harn.(std. trans)	.\$1044.00
WH5040LTS.....	Turn Signal Switch Harness. (pair)\$108.00
WH5040LGB.....	Glove box Light Switch Wire\$6.60
WH5040LML.....	Map Light Wiring\$14.30
WH5040LBT.....	Body and Taillights Harness\$304.80

Note: Tail Lamp Wiring requires the purchase of our TWB501

WH5040LIL..	Interior light & Door Switch 43,43D,46,46S	..\$520.80
WH5040LFT.....	Fuel Tank Connector Wire\$7.70
WH5040LBL.....	Back-up Light Bucket Wires\$39.60
WH5040LLL.....	License Light Bucket Wire\$39.60

1950 BUICK Super / Series 50

WH5050HB.....	Headlight Bucket Wires [pair]\$82.80
WH5050DEH.	Dash, Eng. & Headlight Harn.(auto trans)	.\$1044.00

1950 BUICK Roadmaster / Series 70

WH5070HB.....	Headlight Bucket Wires [pair]\$82.80
WH5070DEH.	Dash, Eng. & Headlight Harn.(auto trans)	.\$1044.00
WH5070IL.....	Interior light and Door Switch (4-dr. sedan)	.\$583.20
WH5070B.....	Body Harness [4dr.sedan]\$186.00
WH5070T.....	Tail Lamp Harness [4dr.sedan]\$168.00

Note: Tail Lamp Wiring requires the purchase of our TWB501

1951 BUICK Special / Series 40

WH5140DEH.	Dash, Eng. & Headlight Harn.(auto trans)	.\$1050.00
WH5140BT...	Body and Taillights Harness, Model 46S\$654.00

1951 BUICK Super / Series 50

WH5150HB.....	Headlight Bucket Wires [pair]\$82.80
WH5150DEH.	Dash, Eng. & Headlight Harn.(auto trans)	.\$1011.60
WH5150BTW....	Body and Tail Lamp Harness [wagon]	...\$370.80

Note: Tail Lamp Wiring requires the purchase of our TWB501

WH5150ILW....	Interior light & Door Switch (wagon)\$552.00
WH5150T.....	Tail Lamp Harness [4dr.sedan]\$146.16

Note: Tail Lamp Wiring requires the purchase of our TWB501

1953 BUICK Special / Series 40

WH5340DEH..	Dash, Eng. & Headlight Harn.(std trans)	..\$1011.60
WH5340DEHA.	Dash, Eng. & Headlight Harn.(auto trans)	.\$950.00
WH5340BTC.....	Body and Tail Lamp Harness [conv]\$934.80
WH5340G.....	Generator Harness\$70.80
WH5340LGB.....	Glove box Light Switch Wire\$6.60
WH5340ML.....	Map Light Wires\$6.60
WH5340PB.....	Parking Brake Warning Light Wires\$14.30
WH5340CL.....	Courtesy Light Harness (convertible)\$46.20
WH5340HM.....	Heater Motor Feed Wire\$39.60
WH5340LL.....	License Light Bucket Wire\$6.60

1953 BUICK Super / Series 50

WH5350HB.....	Headlight Bucket Wires [pair]\$92.40
WH5350FL....	Park and Turn Signal Bucket Wires [pair]\$80.40
WH5350DEH.	Dash, Eng. & Headlight Harn.(auto trans)	.\$1202.40
WH5350BTW....	Body and Tail Lamp Harness [wagon]	...\$376.80
WH5350ILW....	Interior light and Door Switch (wagon)\$547.20
WH5350FT.....	Fuel Tank Connector Wire\$8.80

1953 BUICK Roadmaster / Series 70

WH5370HB.....	Headlight Bucket Wires [pair]\$92.40
WH5370FL....	Park and Turn Signal Bucket Wires [pair]\$80.40
WH5370DEH.	Dash, Eng. & Headlight Harn.(auto trans)	.\$1204.40
WH5370BTC....	Body & Tail Lamp Harness [conv]\$874.80
WH5370BTW....	Body and Tail Lamp Harness [wagon]	...\$376.80
WH5370P....	Power Window, Seat,Top Control Harness	...\$834.00
WH5370PT.....	Power Top Feed Cable\$78.10
WH5370TS.....	Turn Signal Switch Harness.\$102.00
WH5370SR.....	Starter to Relay Harness.\$39.60
WH5370ILW....	Interior light & Door Switch (wagon)\$547.20
WH5370FT.....	Fuel Tank Connector Wire\$8.80

1953 BUICK Skylark / Model 76X

WH53XHB.....	Headlight Bucket Wires [pair]\$92.40
WH53XFL....	Park and Turn Signal Bucket Wires [pair]\$80.40
WH53XDEH.....	Dash, Eng. and Headlight Harn\$1202.40
WH53XBT....	Body & Tail Lamp Harness [conv]\$874.80
WH53XP....	Power Window,Seat,Top Control Harness\$749.70
WH53XPT.....	Power Top Feed Cable\$78.10
WH53XTS.....	Turn Signal Switch Harness.\$102.00
WH53XSR.....	Starter to Relay Harness.\$39.60
WH53XFT.....	Fuel Tank Connector Wire\$8.80

1954 BUICK Special / Series 40

WH5440HB.....	Headlight Bucket Wires [pair]\$91.20
WH5440FL....	Park and Turn Signal Bucket Wires [pair]\$14.30
WH5440DEH.	Dash, Eng. & Headlight Harn.(auto trans)	.\$1188.00
WH5440BT....	Body & Tail Lamp Harness [2-dr. sedan]	..\$742.80
WH5440BTS...	Body & Tail Lamp Harness [4-dr. sedan]	..\$742.80
WH5440GB.....	Glove box Light Switch Wire\$6.60
WH5440ML.....	Map Light Switch Wire\$6.60
WH5440TS.....	Turn Signal Switch Harness.\$111.60
WH5440DL....	Dome Light/Switch Wire (2-dr. sedan)\$111.60
WH5440LBL.....	Back-up Light Bucket Wires (pair)\$12.10
WH5440LL.....	License Light Bucket Wires (pair)\$66.00

1954 BUICK Roadmaster / Series 70

WH5470HB.....	Headlight Bucket Wires [pair]\$91.20
WH5470DEH.	Dash,Eng. & Headlight Harn. (auto trans)	.\$1306.80
WH5470SS.....	Starter Solenoid Harness\$37.20
WH5470DLC.....	Dome Light Harness (conv)\$91.20
WH5470TS.....	Turn Signal Switch Harness.\$111.60
WH5470BTC....	Body and Tail Lamp Harness [conv]\$850.80
WH5470P.....	Power Window,Seat Control Harness\$855.50
WH5470SC.....	Verticle Seat Control Harness.\$94.80

1954 BUICK Skylark / Series 100

WH54XTS.....Turn Signal Switch Harness.\$111.60

1955 BUICK Special / Series 40

WH5540HB..... Headlight Bucket Wires [pair]\$91.20
 WH5540DEH.....Dash, Eng. and Headlight Harn.\$1281.60
 WH5540BT..... Body & Tail Lamp Harness [2-dr. ht]\$694.80
 WH5540TS.....Turn Signal Switch Harness.\$116.40
 WH5540LL.....License Light Bucket Wires (pair)\$49.20

1955 BUICK Century / Series 60

WH5560HB..... Headlight Bucket Wires [pair]\$94.80
 WH5560DEH.Dash, Eng. & Headlight Harn.(auto trans).\$1281.60
 WH5560BTC.... Body & Tail Lamp Harness [conv]\$884.40
 WH5560BTH.... Body & Tail Lamp Harness [4-dr. ht]\$694.80
 WH5560TS.....Turn Signal Switch Harness.\$116.40
 WH5560PW.....Power Window Control Harn (conv)\$873.60
 WH5560PSW....Power Seat Control Harn w/ pwr. wind. ..\$127.20
 WH5560PS....Power Seat Control Harn w/o pwr. wind. ...\$231.60
 WH5560ILR.....Rear Interior Light (4-dr. ht).....\$198.00
 WH5560RC.....Rear Seat Cigar Lighter.....\$37.20

1955 BUICK Roadmaster / Series 70

WH5570HB..... Headlight Bucket Wires [pair]\$91.20
 WH5570DEH.Dash, Eng. & Headlight Harn.(auto trans).\$1311.60
 WH5570BTC.... Body and Tail Lamp Harness [conv]\$841.20
 WH5570PW.....Power Window Control Harn. conv).\$882.00
 WH5570SS.....Starter Solenoid Harness.....\$37.20
 WH5570DLC..... Dome Light Harness (conv).....\$61.20

1957-1960 Wiring Harness Straps



1957-1960 All as required. 2" overall length. Metal.
 WS1\$3.75 ea



1957-1960 All as required. 1/4" high. Metal.
 WS2\$3.75 ea



1957-1960 All as required. 5/8" high. Metal.
 WS3\$3.75 ea

1957 BUICK Special / Series 40

WH5740HB..... Headlight Bucket Wires [pair]\$92.40
 WH5740EH.....Engine and Headlight Harn.....\$499.20
 WH5740HH.....Horn Bucket Wires (pair)\$15.60

1957 BUICK Century / Series 60

WH5760HB..... Headlight Bucket Wires [pair]\$92.40
 WH5760EH.....Engine and Headlight Harn.....\$499.20
 WH5760DH.....Dash Harness.....\$724.80
 WH5760HH.....Horn Bucket Wires (pair)\$15.60
 WH5760SS.....Starter Solenoid Harness.....\$42.00
 WH5760DLW..... Dome Light Harness (wagon)\$68.40

1957 BUICK Roadmaster / Series 70

WH5770CLC..... Dome Light Harness (conv).....\$61.20

1959 BUICK Lesabre

WH59LEH.....Engine and Headlight Harn.....\$508.80
 WH59LSS.....Starter Solenoid Harness.....\$39.60
 WH59LDH.....Dash Harness.....\$1168.80
 WH59LCB.....Circuit Breaker Wires.....\$79.20
 WH59LGB.....Glove Box Light Harness.....\$7.70
 WH59LBHC.....Body Harness. (conv).....\$394.80
 WH59LTL.....Tail Lamp Harness\$307.20
 WH59LWM.....Windshield Wiper Motor Harness.....\$130.80
 WH59LRFW.....Window Harness. (RH Front)\$189.60
 WH59LLFW.....Window Harness. (LH Front).....\$226.80
 WH59LRRW.....Window Harness. (RH Rear).....\$187.20
 WH59LLRW.....Window Harness. (LH Rear).....\$204.00
 WH59LPW.....Power Window Connector Harness\$144.00
 WH59LML.....Map Light Wire.....\$11.00
 WH59LH.....Heater Harness\$52.80
 WH59LHBW.....Hand Brake Wiring\$49.20
 WH59LCLR.....Courtesy Lamp Harness (RH Rear)\$114.66



www.oldbuickparts.com

908-369-3666