

BUICK PARTS: GROUP NUMBERS

Engine • Clutch • Decals.....	Group 0
Cooling • Oiling • Grills	Group 1
Electrical • Lamps	Group 2
Fuel • Carburetion • Exhaust.....	Group 3
Transmission • Brakes	Group 4
Wheels • Propeller Shaft • Rear Axle	Group 5
Front Suspension • Steering	Group 6
Frame • Springs • Shocks • Bumpers	Group 7
Hood • Front Fenders • Running Boards.....	Group 8
Heater • Air Conditioner • Firewall • Radio • Antenna	Group 9
Glass • Doors • Cowl • Weatherstrip • Wiper • Dash.....	Group 10
Rear 1/4 Glass • Seats • Door Sills • Dome Lenses	Group 11
Rocker Panels • Rear Sheet Metal • Deck Lid.....	Group 12
Convertible Tops and Parts	Group 13
Door Panels • Misc. Interior • Headlinings	Group 14
Carpet • Floor Mats • Trunk Linings	Group 15
Literature.....	Group 16

-ATTENTION-

This catalog pertains to
1963 and Up Riviera ONLY

We also have catalogues and stock Buick parts for:

1930's and Up All models

1961 and Up Special, Skylark, Sportwagon and Gran Sport

1961 and Up LeSabre, Invicta, Wildcat,
Electra 225, Centurion, Century and Apollo

1973 and Up Regal, Grand National, T-Type and GNX

Please inquire about separate catalogs for the above Buicks

www.oldbuickparts.com

All rights reserved. No part of this publication may be reproduced without prior written permission from CARS, Inc. Illustrations in this catalog are representations only and may not exactly depict any particular part or part number. Prices subject to change without notice.

Typical 1963-1975 Buick V-8 Engine

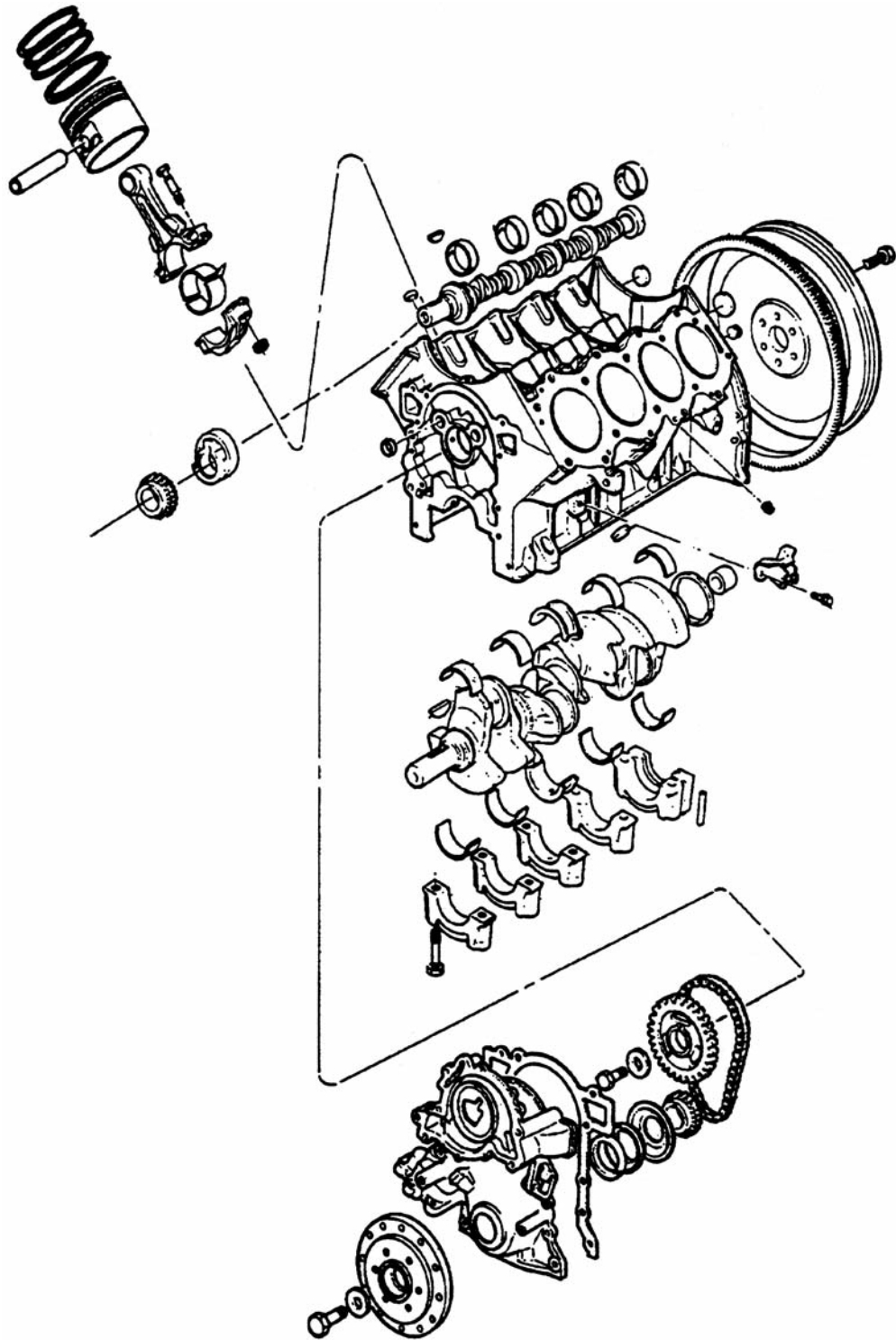

Engine Parts (Group 0)

Motor Mounts (.027)



1963-1965 All except 65 GS front motor mounts.
MM615.....\$58.00 pr.

1967-1976 All with four hole flange. Left and right sides.
MM676.....\$52.75 pr.

Motor Mount Rebuilding Service

We can only rebuild mounts listed below.
Please inquire.

1965-1966
1965: GS;
1966: Front motor mounts.
MM656R.....\$114.75 pr.

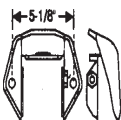

1967-1970 Riviera first type, #'s 1231008-9
There are two types. This is not the interlocking type.
MM670.....\$192.00 pr.

Crankshaft Main Bearing Sets

1963-1966 Riviera 401-425 Main bearing set.
MBS596.....\$129.75 set

1967-1969 All 430 engines. Main bearing set.
MBS679.....\$84.75 set

1970-1976 All 455 engines. Main bearing set.
MBS706.....\$116.50 set

Connecting Rods

1963-1965 401 and 425 engines.
CR596.....\$43.25 ea.

1967-1972 430 and 455 engines.
CR672.....\$59.25 ea.



Connecting Rods Bearings

1963-1976
RBS576.....\$89.50 set



Timing Chain Covers

1963-1966 All.
TC576.....\$299.00 ea.

1967-1976 All 400, 430 and 455 engine. A top quality item manufactured from 356-T6 aluminum with improvements such as upgraded coolant and oil passages. Includes neoprene front seal.
TC676.....\$479.00 ea.



Timing Cover Seals

Our modern steel housed, silicon seals replace the OEM "rope" seal and steel retainer. A spring insert keeps pressure against balancer for improved sealing.



1963-1966 All
TCS536L.....\$11.75 ea.

1967-1976 All
TCS650.....\$17.00 ea.

Timing Chain Sets

1963-1966 All. Timing chain set with iron cam gear.

TS576.....\$108.50 set
TC536.....Chain Only.....\$34.50 ea.



1967 Early 430 engines.
TS67E.....\$68.75 set

1967-1976 Timing chain set.
1967: Late 430 engines;
1968-1976: All.
TS676.....\$56.25 ea.

Timing Cover Gasket Sets

Sets Contain Standard Rope Seal

1963-1966 All.
TCS536.....\$27.25 set

1967-1976 All.
TCS676.....\$25.25 set



Camshafts



- 1963-1966** All.
CS576\$154.50 ea.
- 1967-1976** 430 and 455 engines, except stage one.
CS676\$167.25 ea.
- 1982-1983** Riviera w/ V-6; 1984-1985 All with V-6 Turbo.
CS785\$95.50 ea.
- All Years.** All Engines. Cam break-in lube.
CL300.....\$6.75 ea.

Camshaft Bearings Sets

- 1963-1966** All.
CBS576\$38.50 set
- 1967-1976** All.
CBS676\$54.00 set

Pistons

- 1961-1966** All 400, 401 engines. Piston and pin.
P401.....\$54.50 ea.
P401S.....(Set of 8).....\$375.00 set
- 1963-1966** All 425 engines. Piston and pin.
P425\$54.50 ea.
P425S.....(Set of 8).....\$375.00 set
- 1970-1976** All 455 engines. Piston and pin.
P706\$57.25 ea.
P706S.....(Set of 8).....\$449.50 set

Piston Ring Sets

- 1963-1966** 401 engines.
PRS401C.....(cast iron).....\$94.50 set
PRS401M.....(moly).....\$195.00 set
- 1963-1966** 425 engine. Cast iron.
PRS425C.....\$78.25 set
- 1967-1969** 430 engine. Cast iron.
PRS430C.....\$138.00 set
- 1970-1976** 455 engine.
PRS455C.....(cast iron).....\$64.50 set
PRS455M.....(moly).....\$95.00 set
- 1977-1981** 350 engine.
PRS350M.....(moly).....\$64.50 set



Harmonic Balancers

- 1967-1976** all 400, 430, 455 engines.
Sold outright.
HB676\$269.50 ea.



Harmonic Balancer Rebuilding Service (.659)

Balancers are completely disassembled shot peened and inspected. Threaded holes are repaired and new seal saver is installed.(non-rope seal apps.) New silicone rubber is injected, then vulcanized for proper bonding. Please remove any bolted pulleys before sending. For those not listed, please inquire.

- 1959-1966** All 400, 401 engines. Riveted type.
HB401RS\$155.50 ea.
- 1963-1966** All 425 engines. Riveted hub seal dia. 2.00 inches, 1.440 id.
HB425RS\$154.00 ea.
- 1977-1981** All 350 engines. .750 wide ring externally balanced hub and ring.
HB350RS\$88.25 ea.
- 1967-1976** 430,455 engine. 1.100 wide ring. Externally balanced.
HB455RS\$111.50 ea.

Harmonic Balancer Bolt

- 1967-1976** All 400, 430, 455 engines.
HBB676\$7.50 ea.

Harmonic Balancer Washer

- 1967-1976** All 400, 430, 455 engines.



www.oldbuickparts.com
908-369-3666

Engine Parts (Group 0)



Valves-Intake

1963-1966 All.	
IV596	\$14.25 ea.
1967-1976 430 and 455. Except GS.	
IV676	\$11.50 ea.
1968-1980 350 engine.	
IV680	\$10.00 ea.

1971-1974 455 Stage 1.	
IV714	\$17.00 ea.

Valves - Exhaust

1963-1966 All.	
EV596	\$16.50 ea.
1967-1974 430 and 455 engines. Except GS.	
EV674	\$14.75 ea.
1975-1976 455 engines.	
EV756	\$18.50 ea.

Valve Guides



1963-1965 401 and 425 engines. (int./ext.).	
VG733	\$4.00 ea
1966 All with 401 engine. Valve guide. (intake).	
VG937	\$3.00 ea.
1966 All with 425 engine. Valve guide. (intake).	
VG733	\$4.00 ea.
1967-1976 All. Valve guide. (intake).	
VG6113	\$2.75 ea.
1967-1976 All. Valve guide. (exhaust).	
VG6114	\$2.75 ea.

Freeze Plug Kits

Kits contain necessary plugs for block, cam, oil holes.
"B" kits contain brass plugs for water jackets.

1963-1966 All.	
FPK536	\$18.50 each kit
1967-1976 All 430 and 455 engines. Steel.	
FPK670	\$10.00 ea.
1967-1976 All 430 and 455 engines. Brass.	
FPK670B	\$15.50 ea.
1977-1980 All 350 engines. Steel.	
FPK640	\$10.50 ea.
1977-1980 All 350 engines. Brass.	
FPK640B	\$10.00 ea.

Flywheels

Two of our Latest Reproductions

1967-1976 All. 430, 455 engines with auto transmission.	
FW676	\$99.00 ea.



Valve Spring Retainers (.310) (Keepers)

1963-1975 all V-8 engines.	
32 pairs needed per car.	
VR365	\$3.00 pr.
VR365S.....Set of 32.....	\$42.50 set



Valve Springs

1963-1966 All. (inner).	
VS536	\$5.00 ea.
VS536S.....Set of 16.....	\$58.00 set
1963-1966 All. (outer).	
VS596	\$4.75 ea.
1963-1966 All. Complete set of 16 valve springs.	
VS596S.....	\$52.25 set
1967-1972 All except GS. Intake and exhaust.	
VS672	\$4.50 ea.
VS672S.....Set of 16.....	\$58.00 set
1971-1974 Riviera GS. Intake and exhaust.	
VS714	\$4.75 ea.
1973-1974 All. Intake and exhaust.	
VS734	\$4.75 ea.

Valve Seat Inserts

1963-1966 All. (intake).	
VSI592	\$4.75 ea.
1963-1966 All. (exhaust).	
VSI590	\$4.75 ea.
1967-1969 430 engines. (exhaust).	
VSI648	\$8.00 ea.
1967-1974 All except Riviera GS. (intake).	
VSI674	\$8.00 ea.
1970-1974 All except Riviera. (exhaust).	
VSI704.....	\$5.00 ea.

Valve Stem Seals

1963-1966 All.	
VSS536	\$3.00 ea.
1967-1974 350, 430 and 455 engines.	
VSS674	\$2.75 ea.



Rear Main Seal

1967-1976 All. Replaces OEM "rope" seal. Metal encased lip seal.	
RMS650	\$25.25 ea.

Rocker Arm Assemblies (Sold Outright)

- 1968-1981** 350 engine.
RAA680\$265.00 pr.
- 1970-1971** 455 engine.
RAA702\$179.50 pr.

Rocker Arm Assembly Rebuilding

- 1961-1966** All 364, 401, 425 engines.
RAA596.....\$296.50 pr.
- 1967-1976** All 400, 430, 455 engines.
RAA676.....\$262.25 pr.

Rocker Arm Shafts

- 1963-1966** 401 and 425 engines. Either side.
RS536.....\$48.50 ea.
RS536P.....Pair.....\$89.50 pr.
- 1967-1969** 430 engines. Either side.
RS689.....\$55.00 ea.
- 1977-1976** 455 engine. Either side.
RS705.....\$55.00 ea.
- 1977-1981**
RS700.....\$39.50 ea.

Rocker Arms and Sets

- 1963-1966** All 401, 425 engines. Reproduced in steel. Set includes 16 rocker arms.
RAS536.....\$208.50 set



- 1968-1969** 350, 400, 430 Engines.
Intake #1, 4, 5, 8. Exhaust #2, 3, 6, 7.
RA689A\$17.00 ea.



- 1968-1969** 350, 400, 430 Engines.
Intake #2, 3, 6, 7. Exhaust #1, 4, 5, 8.
RA689B\$17.00 ea.

- 1968-1969** 350, 400, 430 Engines.
Complete rocker arm set.
RA689S\$259.00 set

- 1970-1975** 455 Engine. Intake #1,4,5,8. Exhaust #2,3,6,7.
RA705A\$8.50 ea.

- 1970-1975** 455 Engine. Intake #2,3,6,7. Exhaust #1,4,5,8.
RA705B\$8.50 ea.

- 1970-1975** 455 Engine. Complete rocker arm set.
RA705S\$105.25 set

Rocker Arm Retainers



- 1970-1972** All. Rocker arm retainers.
For use with aluminum rocker arms.
16 per car. Nylon.
RR702.....\$1.75 ea.

Oil Slinger

- 1977-1981** All 350 engines.
OS615\$11.75 ea.



www.oldbuickparts.com
908-369-3666

Engine Parts (Group 0)

Valve Rocker Cover Parts



1963-1966 Valve rocker cover bolt grommet.
Four per car.
VCG572\$3.50 ea.



1963-1966 Valve cover vent, rubber grommet.
(1" hole).
VG634\$7.75 ea.

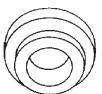

1964-1967 Solid rocker cover plug.
CP647\$11.75 ea.



1967-1974 Intake manifold vent grommet.
VG634\$7.75 ea.

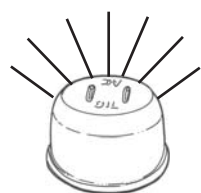

1964-1967
1964-1966: GS with 2-4 carbs;
1967: with engine dress up kit.
"AC OIL" Chrome twist on cap.
OC647.....(chrome)\$31.00 ea.
OC397.....(black).....\$25.25 ea.

Breather Tubes (1.762)

(Air Cleaner to Rocker Cover)



1968-1969 All 350, 400, 430 engine
except 1968 2bbl.
VT689\$18.50 ea.



1970-1971 all V-8; **1972** all 455
engines.
VT704\$16.50 ea.

Crankcase Vent Hose

(To Carb) (1.726)



1971-1975 All 350 and 455 engines
with 4BBL carb. (Formed hose).
VH725.....\$20.25 ea.

Aluminum Valve Covers



1963-1966 all 401, 425 engines. Grooved with "BUICK" as
original. Nice reproduction! Matte finish.

AVC536.....\$199.00 pr.

1963-1966 all 401, 425 engines. Grooved with "BUICK" as
original. Nice reproduction! Bright finish. Includes PCV
grommet and gaskets.

AVC536B\$199.00 pr.



1953-1966 all with aluminum valve covers.
Spark plug wire retainer stanchion. Chrome
plated.

WRS636.....\$37.50 pr.

Powder coated so not to flake, peel or chip. Tall valve covers
allow use of adjustable roller rockers, large valves, springs
and retainers. Thick aluminum construction allows for even
gasket compression and proper sealing. Will not bend, dent
or distort. Results in reduced engine noise and heat.

AVC350.....(350 Engines)\$174.50pr.



AVC455..(1967-1976 400, 430, 455 Engines)...\$167.25 pr.



1967-1976 Valve cover retaining nut and
plate.
RCS686.....\$3.75 ea.



1967-1976 Valve cover retaining nut and
plate. Chrome plated.
RCS686C\$5.50 ea.



1967-1976 Valve cover retainer with
tall stud.
RCS686T.....\$5.50 ea.



1967-1976 Valve cover retainer with
tall stud. Chrome plated.
RCS686TC.....\$5.75 ea.

Full Engine Overhaul Gasket Sets

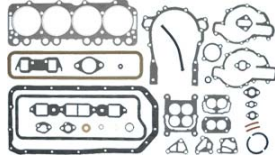

1963-1966 All.
FGS576\$129.50 set

1967-1976 430 and 455 engines. *
FGS676\$81.25 set

** Intake manifold gasket not included, please see Group 3*

Cylinder Head Gasket Sets

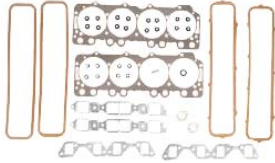

1963-1966 All.
HGS576\$74.50 set

1967-1976 430 and 455 engines. *
HGS676\$51.00 set

** Intake manifold gasket not included, please see Group 1.*

Cylinder Head Gaskets



1963-1966 All.
HG576\$67.50 pr.

1967-1976 430 and 455 engines.
HG676\$40.75 pr.

Valve Cover Gaskets



1963-1966 All.
VCG536.....\$16.50 pr.

1967-1976 All.
VCG676.....\$17.75 pr.

Push Rod Cover Gaskets



1963-1966 All.
PRG576.....\$9.75 ea.

Timing Cover Gasket Sets

Sets Contain Standard Rope Seal



1963-1966 All.
TCS536.....\$27.25 set

1967-1976 All.
TCS676.....\$25.25 set

Push Rods

1963-1966 All.
PR597\$5.75 ea.
PR597S.....(complete set of 16).....\$78.00 set

1967-1969 All.
PR669.....\$3.75 ea.
PR669S.....(complete set of 16).....\$58.00 set

1970-1976 All.
PR706.....\$4.25 ea.
PR706S..... (complete set of 16).....\$58.00 set

1977-1981 All 350 Engines.
PR701.....\$4.25 ea.
PR701S.....(complete set of 16).....\$58.00 set

Hydraulic Valve Lifters



1963-1966 All.
VL567\$9.50 ea.
VL567S.....(set of 16).....\$139.50 set

1967-1969 400-430 engines.
VL679\$7.00 ea.
VL679S.....(set of 16).....\$102.50 set

1970-1981 All 350 and 455 engines.
VL680\$4.75ea.
VL680S.....(set of 16).....\$69.50 set

Buick Engine Enamel (Group 0)

Exact Original Colors to Authenticate your Engine. Our Enamels are the Finest available. Very High Temperature. Can be easily Brushed or Sprayed to Obtain a Rich Deep Gloss. Sold in Quart or Spray Cans.

*** Note: Spray cans can not be shipped by Air.**

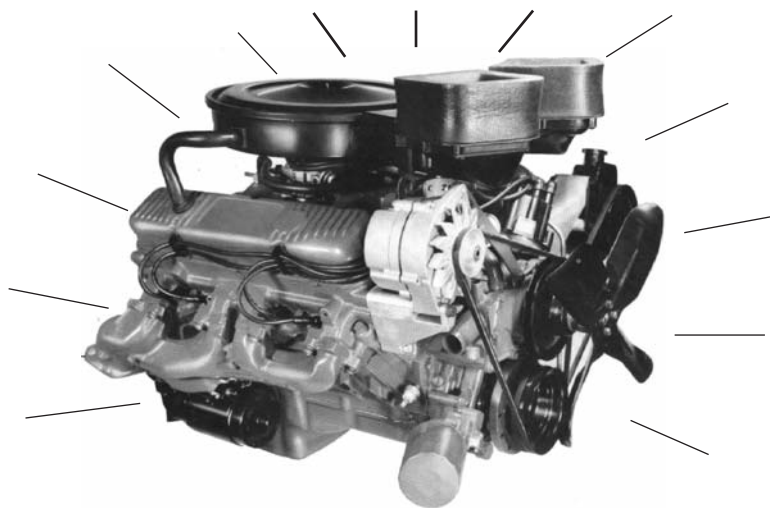

High Heat - High Gloss



Quart Cans



12 oz.
Spray Can

1963-1964	Buick Silver	EP614.....\$27.50 qt.	EP614S.....\$14.00 spray can
1963-1967	Buick Green	EP536.....\$27.50 qt.	EP536S.....\$14.00 spray can
1965-1976	Buick Red	EP644.....\$27.50 qt.	EP644S.....\$14.00 spray can

Cast Iron Paint



Extremely High Temperature - 1800 degrees. Excellent for manifolds and exhaust systems. **Will not burn OFF.**
 EP3.....(pint).....\$32.00 ea.
 EP3S.....(spray can).....\$19.50 ea.

Engine Compartment and Chassis Paint

Our Satin Black Enamel contains the correct blend of dulling agents to give that "Authentic New Look". Use it on inner fender wells, under hood, radiator supports brackets, fan, air cleaner, etc. It is also correct for chassis.

All Years and Models

EP2.....(quart).....	\$24.50 ea.
EP2S.....(spray can).....	\$14.00 ea.

Spray Gun for Engine Enamels

Self-propelled unit enables you to spray up to 16 oz. of paint. Great for use on engine enamels listed above that are not available in spray cans.

SG220	\$8.25 ea.
Refill cartridge.	
SGR220	\$6.50 ea.



1963-1966 Air Cleaner I.D. Plates

Not just a "decal" but a high quality silk screened impression on a die cut reflective aluminum disc. Add the final touch to your highly detailed engine compartment. Will not fade or wrinkle. Easy to apply. Absolutely Show Quality. Approved and Licensed by Buick.

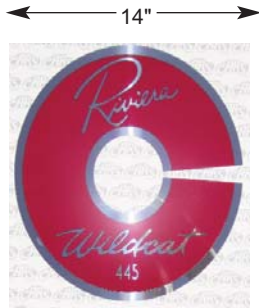

1963 401 engine "Riviera Wildcat 445".
D115A.....\$37.50 ea.



1963 425 engine "Riviera Wildcat 465".
D116A.....\$37.50 ea.

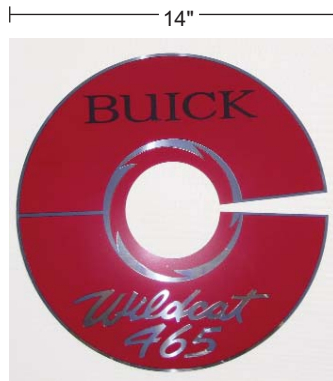

1964 All; **1966** Riviera GS "Buick Wildcat 465". 425 Engines.
D94A.....\$37.50 ea.



1965-1966 401 engines. 10" diameter
"Buick Wildcat 445".
D92A.....\$37.50 ea.



1965-1966 425 engines except GS.
"Buick Wildcat 465". 10" diameter.
D99A.....\$37.50 ea.

Riviera Decals (Group 0)

Air Cleaner Decals

- D115 **1963** "Riviera Wildcat 445" for engines 401..\$15.25
- D116 **1963** "Riviera Wildcat 465" for engines 425..\$15.25
- D161 **1963** Riviera air cleaner snorkel Wildcat head.\$5.00
- D45 **1963** 401 Engine A96C Air Filter Instruction...\$5.00
- D96 **1965** 401 Eng. Air cleaner instruct. #6420861.\$6.25
- D90 **1964-1966** 401 and 425 eng. Side of air cleaner decal (AC-A85C).....\$5.50
- D94 **1964 All & 1966** 425 engine "Buick Wildcat 465". Red 14" diameter.....\$12.50
- D56 **1968-1976** "Keep your GM car all GM". #6424826.....\$5.00
- D126 **1964-1966** "Super Wildcat", for 2X4-BBL cars. \$8.00
- D99 **1965-1966** all 425 engines except GS. "Buick Wildcat 465" 10".....diameter.....\$12.50
- D92 **1965-1966** 401 engine "Buick Wildcat 445". Red 10" diameter.\$12.50
- D98 **1967** "Buick Wildcat Power". Decal\$8.25
- D181 **1967** Air cleaner, front.....\$4.00
- D57 **1967-1969** "430-4" Red & white crescent.\$4.75
- D54 **1970-1975** "455-4" Red & white crescent.\$5.00
- D51 **1970-1975** "GS-455" Red & white crescent...\$5.00
- D51E **1970-1975** "GS-455" Red & white crescent...\$8.50
- D52 **1970-1974** "Stage 1" Red & white crescent...\$6.00
- D314 **1974-1976** "455-2V".....\$5.00

Valve Cover Decals

- D65 **1967-1969** "Buick 430-4" Black and Silver.\$5.00

NEW Car Window Sticker and Booklet

- D127 **1963-1964** NEW Car Window Sticker.....\$5.00
- D371 **1964** NEW Car Price Booklet.....\$4.75
- D372 **1965** NEW Car Price Booklet.....\$4.75
- D129 **1965-1966** NEW Car Window Sticker.....\$5.00
- D373 **1966** NEW Car Price Booklet.....\$4.75
- D131 **1967** NEW Car Window Sticker\$5.50
- D344 **1968** NEW Car Window Sticker\$5.50
- D374 **1971** NEW Car Price Booklet.....\$4.75
- D140 **1971-1974** NEW Car Window Sticker.....\$5.50



D 108



D 112



D 117



D 111



D310



D 118

Engine Compartment Decals



D-46

- D375 **1961-1965** Electric Antenna Tag\$4.50
- D205 **1961-1966** "GM" Antifreeze Tag\$4.75
- D171 **1963** Riviera cooling system (on fan shroud)....\$4.75
- D130 **1963-1964** Battery warning decal.\$4.50
- D46 **1963-1968** "Optikleen". Washer bottle label. ...\$3.75
- D107 **1963-1968** "Optikleen". Bottle cap decal\$4.00
- D80 **1964** Cooling system sticker (on fan shroud)....\$4.75
- D100 **1963-1975** "GM antifreeze" sticker.\$4.00
- D125 **1965-1966** Battery Warning Decal.....\$4.50
- D357 **1966-1967** "Canada" oil change decal.....\$5.50
- D358 **1968-1969** "Canada" oil change#734791 \$5.50
- D179 **1968-1969** "Riviera" Radiator Cap decal\$4.00
- D63 **1968-1974** "Positive to pos." Battery sticker. ...\$4.25
- D122 **1965-1966** Cooling system decal (downflow) ...\$5.00
- D246 **1965-1966** Cross flow radiator decal\$5.50
- D77 **1969-1975** Windshield washer bottle decal. ...\$5.00
- D359 **1970-1971** "Canada" oil change #733639\$5.00
- D210 **1970-1972** Cooling system decal.....\$4.25
- D228 **1980-1983** Glow plug caution 563050\$5.50

Trunk Stickers

- D121 **1963** Riviera Jack instructions.\$4.50
- D348 **1963-1964** Jack Base Decal.....\$4.50
- D213 **1964** Riviera Jack Instructions.\$5.00
- D160 **1965** Riviera Jack Instruc. trunk lid sticker.....\$5.00
- D214 **1965** Riviera GS Jack instructions.\$4.50
- D142 **1966-1967** Jack Instructions.\$4.50
- D345 **1969** Riviera Jack Instructions\$4.50
- D346 **1970** Riviera Jack Instructions\$4.50
- D395 **1970-1972** Spare Tire inflation decal.....\$5.00
- D412 **1971** Riviera Jack Instructions\$5.00
- D396 **1971-1973** Canada Limited Slip decal\$5.00
- D150 **1972** Jack Instructions.\$4.50
- D216 **1973** Tire stowage with regular wheel.\$4.75
- D347 **1973** Riviera Jack Instructions\$4.50
- D153 **1973** Tire stowage with specialty wheel.....\$4.50
- D154 **1974** Jack Instructions.\$4.50
- D155 **1974** Tire stowage with regular wheel.\$4.50
- D306 **1975-1976** Tire stowage with regular wheel. ...\$4.75

Garage Wall, Tool Box Decals

- D108 Old Style Buick Logo (blue and white).....\$8.50
- D111 "Genuine Buick Parts" 2" x 2 1/2" Water Transfer..\$1.50
- D112 "Buick 8" 2" x 2 1/2" Water Transfer.....\$1.50
- D117 "Authorized Service" (10" diameter red, white and blue decal).....\$8.50
- D118 "Authorized Service" (5" diameter red, white and blue decal).....\$6.50
- D310 Tri-Shield 12" (red, white and blue).....\$9.75

Interior Decals and Stickers

D386	1961-1964 Delco Battery Certificate	\$4.00
D375	1961-1965 Electric Antenna Tag	\$4.75
D71	1963-1965 Casco automatic lighter tag.	\$4.00
D279	1965-1968 Delco Battery Certificate	\$4.00
D384	1965-1968 Litter Box decal	\$4.75
D362	1966 Glove Box Tire Pres. (exc. Wildcat GS)....	\$5.00
D95E	1966-67 Embossed "GM mark of excellence" ..	\$5.50
D369	1966-1969 NEW Car Factory Build Sheet	\$5.50
D376	1967 Climate Control Tag	\$5.00
D91	1967 Glove Box Tire Pressure.	\$5.50
D382	1968 "Fasten Seat Belts" decal	\$4.50
D259	1968-1969 Headlight Instruction Decal.....	\$5.00
D377	1968-1970 Climate Control Tag	\$5.00
D381	1968-1970 Luggage Instruction Tag	\$5.50
D55	1968-1976 "GM mark of excellence" sticker.....	\$3.75
D55E	1968-76 Embossed "GM mark of excellence" ..	\$6.65
D383	1969 Lighter Instruction decal.....	\$4.75
D340	1969 Tire Pressure Decal	\$5.00
D388	1969-1972 Ignition Lock/Start Sleeve 6".....	\$5.00
D389	1969-1972 Ignition Lock/Start Sleeve 7".....	\$4.75
D105	1971 Tire Pressure Decal.	\$5.00
D380	1971-1973 Starting Instruction Tag.....	\$4.75
D378	1972-1973 A.C. Instruction Tag	\$5.75
D137	1972 Tire Pressure Decal.	\$5.50
D139	1973 Tire Pressure Decal.	\$5.00
D390	1973 Unleaded Fuel Sun Visor Sleeve	\$5.50
D342	1973-1974 Glove Box Fuel recommend	\$4.75
D391	1973-1974 Ignition Lock Instruction Sleeve ...	\$5.00
D393	1974-1976 Instruction Sun Visor Start Sleeve...	\$4.75
D366	1976-1977 Headlight Dimmer Instruc. Tag	\$4.75
D392	1975-1977 Instruction Sun Visor Start Sleeve...	\$4.75

Exterior Decals

D398	Buick Tri-Shield 1 1/2" Wheel Center Decal ...	\$4.75
D399	Buick Tri-Shield 2 7/8" Wheel Center Decal ...	\$4.75
D400	1970 Gas Cap Caution Decal (California Cars)....	\$5.50
D405	Unleaded Fuel Only 5" Straight - White	\$5.00
D406	Unleaded Fuel Only 5" Straight - Black.....	\$5.00
D407	Unleaded Fuel Only 4" Straight - Black & White	\$5.00
D408	Unleaded Fuel Only 4" Straight - Black & White	\$5.00
D410	Unleaded Fuel Only 3" Curved - White	\$5.00
D411	Unleaded Fuel Only 3" Curved - Black.....	\$5.00



www.oldbuickparts.com
908-369-3666

Emission Stickers

D128	1967-1969 430 Automatic transmission.....	\$5.00
D265	1968 Buick 430 - Automatic transmission.....	\$5.00
D309	1970 455 Automatic transmission.....	\$5.00
D62	1970 All with stage 1 engine.....	\$5.00
D294	1970 All V-8 "Evaporative control" decal	\$5.00
D102	1970 455 Stage 1 Automatic transmission - After 1/1/70	\$5.00
D290	1970 455 Stage 1 Automatic transmission Before 1/1/70	\$5.00
D270	1971 Buick GS 455 Automatic transmission...	\$6.00
D269	1971 Buick 455 Stage 1 Automatic and Manual transmission.....	\$5.50
D120	1972 455 Stage 1 - Automatic and Manual transmission.....	\$5.00
D307	1972 All 455	\$5.00
D312	1973 All 455	\$6.00
D313	1973 All 4555 Stage 1.....	\$6.25
D315	1974 455 4BBL Auto. Trans.....	\$6.25
D316	1974 455 Stage 1.Auto. Trans.....	\$6.25

Air Conditioning Tags

D379	1963 "Air Conditioned" Window decal	\$5.00
D172	1963 Compressor warning decal.	\$5.00
D297	1964 Frigidaire compressor sticker.....	\$5.75
D190	1965 Harrison air conditioner box sticker.....	\$5.00
D187	1965 Frigidaire compressor sticker.....	\$5.75
D191	1966 Harrison air conditioner box sticker.....	\$5.00
D251	1966 Frigidaire compressor sticker.....	\$5.00
D192	1967 Harrison air conditioner box sticker.....	\$5.50
D298	1967-1968 Frigidaire compressor sticker.....	\$5.50
D193	1968 Harrison air conditioner box sticker.....	\$5.00
D252	1969 Frigidaire compressor sticker.....	\$5.75
D194	1969 Harrison air conditioner box sticker.....	\$5.00
D253	1970 Frigidaire compressor sticker.....	\$5.00
D195	1970 Harrison air conditioner box sticker.....	\$5.75
D196	1971 Harrison air conditioner box sticker.....	\$5.00
D299	1971 Frigidaire compressor sticker.....	\$5.75
D197	1972 Harrison air conditioner box sticker.....	\$5.00
D189	1972 Frigidaire compressor sticker.....	\$5.75
D198	1973 Harrison air conditioner box sticker.....	\$5.00
D229	1973 Riviera Harrison Box #ABE 50A72A.....	\$5.75
D199	1974 Harrison air conditioner box sticker.....	\$4.25
D200	1975 Harrison air conditioner box sticker.....	\$5.00
D201	1976 Harrison air conditioner box sticker.....	\$4.25
D415	1977 Harrison air conditioner box decal. ACM-050-77B	\$6.25
D260	1978 Harrison air conditioner box decal. ACM-050-78B	\$6.25
D256	1978-1980 Delco A.C. compressor 1131198	\$6.25
D233	1979 Harrison air conditioner box decal. ACM-056C-798	\$6.25
D250	1980 Harrison air conditioner box decal. EBA-112-80B	\$6.25
D258	1981 Delco A.C. compressor 1131198	\$6.25
D255	1981 Harrison air conditioner box decal. 3042218	\$6.25